

# AirBorne WindSports

**AUSTRALIA PTY. LTD.**

**ACN 002 700 398**

UNIT 22/30 KALAROO ROAD, REDHEAD, NSW 2290 AUSTRALIA

Phone (02) 4944 9199 International +61 2 4944 9199

Fax (02) 4944 9395 International +61 2 4944 9395

E mail [fly@airborne.com.au](mailto:fly@airborne.com.au)

[www.airborne.com.au](http://www.airborne.com.au)

**EDGE X SERIES MICROLIGHTS with**

**Wizard 3 or Streak 2 Wing**

**PILOT HANDBOOK**

ISSUE 1.9

This Pilot Handbook details the operation and maintenance of the EDGE weight shift controlled aircraft in accordance with the requirements of Australian Civil Aviation Order 95.32.

Signed

For AirBorne WindSports Pty Ltd.

Dated \_\_\_\_\_ day of \_\_\_\_\_ 19\_\_\_\_\_

**Copyright Notice**

©Copyright AirBorne WindSports Pty. Ltd. 1992

All rights reserved.

Except where the Copyright Act otherwise allows, no part of this Pilot Handbook may be reproduced, stored in a retrieval system in any form or transmitted by any means without prior permission in writing of AirBorne WindSports Pty Ltd.

THIS PAGE INTENTIONALLY BLANK.

## **1 PILOT HANDBOOK ISSUE DETAILS**

### **1.1 Warning Notice**

**THE OWNER AND OPERATOR MUST UNDERSTAND THAT DUE TO INHERENT RISK INVOLVED IN FLYING A MICROLIGHT/TRIKE/POWERED HANG GLIDER, NO WARRANTY IS MADE OR IMPLIED, OF ANY KIND, AGAINST ACCIDENTS, BODILY INJURY OR DEATH OTHER THAN THOSE WHICH CANNOT BY LAW BE EXCLUDED.**

**THE SAFE OPERATION OF THIS AIRCRAFT RESTS WITH YOU, THE PILOT.**

**WE BELIEVE THAT IN ORDER TO FLY SAFELY YOU MUST MATURELY PRACTICE AIRMANSHIP.**

**OPERATIONS OUTSIDE THE RECOMMENDED FLIGHT ENVELOPE SUCH AS AEROBATIC MANOEUVRES OR ERRATIC PILOT TECHNIQUE MAY ULTIMATELY PRODUCE EQUIPMENT FAILURE. YOU ARE REFERRED TO THE OPERATING LIMITATIONS ON PAGE 17 OF THIS MANUAL**

**THE SETTING UP AND BREAKING DOWN OF A MICROLIGHT/TRIKE/POWERED HANG GLIDER, TRANSPORTATION AND FLYING ITSELF WILL HAVE AN EFFECT OVER TIME ON ITS STRUCTURAL INTEGRITY.**

**THE AIRCRAFT WILL REQUIRE MAINTENANCE AS OUTLINED IN THE MAINTENANCE SECTION OF THIS HANDBOOK.**

**LIKE ANY AIRCRAFT SAFETY DEPENDS ON A COMBINATION OF CAREFUL MAINTENANCE AND YOUR ABILITY TO FLY INTELLIGENTLY<sup>3</sup> AND CONSERVATIVELY.**

**WE HOPE THAT YOUR AIRCRAFT WILL PROVIDE YOU WITH MANY HOURS OF SAFE FLYING**

### **1.2 Handbook Issue**

This Pilot Handbook was issued by AIRBORNE WINDSPORTS Pty Ltd for use with the operation and maintenance of the weight shift controlled aircraft described in Section 0.

This aircraft has been designed and manufactured in accordance with the Australian Civil Aviation Safety Authority requirements for weight shift controlled aircraft for operation as detailed in Civil Aviation Order 95.32.

Approval for operations is contained within the Civil Aviation Authority Document "Notification of Aircraft Type Eligible for Operation under the provisions of Civil Aviation Orders Section 95.32 Number AD32-5, AD32-6, AD32-7 and AD32-8.

Aircraft fitted with the Rotax 582 and 503 engine with GSC, Airborne(IVO) and Brolga ground adjustable propellers have been noise certified by CASA to the requirements of CAO 101.55.



**1.4 Registration Details**

Nationality

Registration number   
Wizard Wing

Registration number   
Streak Wing

**1.5 Pilot Handbook Issue Details**

Pilot Handbook Issued By   
for AirBorne WindSports Pty. Ltd.

Date

**PILOT HANDBOOK - EDGE SERIES MICROLIGHTS**

**1.6 Aircraft Warranty**

This warranty extends to new **Aircraft** (trike and wing) and/or accessories and equipment manufactured by **AIRBORNE WINDSPORTS PTY LTD** (“AirBorne”) and shall not embrace any other aircraft accessories or equipment in the sale.

**AIRBORNE** warrants to the customer the aircraft and/or accessories manufactured or supplied by **AIRBORNE** to be free from defect in material and workmanship under normal use and service and of merchantable quality and fit the purpose for which they are ordinarily used.

This Warranty shall subsist for the warranty term that shall be a period of **ninety (90) days** from the date of delivery of the aircraft not withstanding the number of hours flown but subject to the aircraft remaining the property of the customer.

This warranty does not exclude any rights implied in favour of any customer by any applicable Australian Federal and State legislation.

**AIRBORNE** will make good any parts required because of defective material or workmanship as set in the Warranty except the engine and tyres in respect of which the Warranty is limited to that provided by the engine and tyre manufacturer respectively.

**THE WARRANTY WILL NOT APPLY TO:**

- Any mechanical adjustments, parts, replacements, repairs or other servicing that in the judgement of **AIRBORNE** are made or should be made as maintenance.
- Any defect caused by any alteration or modification not approved by **AIRBORNE** or, as the case may be, the engine manufacturer.
- Any defect caused by the fitment of parts that are not made or approved by **AIRBORNE** or, as the case may be, the engine manufacturer.
- Any defect caused by misuse, accidents, negligence or failure to carry out proper maintenance service.
- Damage caused by continued operation of the aircraft after it is known to be defective.
- Any defect or consequential loss, damage or injury caused by overloading.
- Loss of use of the aircraft, loss of time, inconvenience, damages for personal injuries, loss of property or other consequential damages.
- Failure due to wear and tear, accident, fire, incorrect or incomplete rigging and/ or assembly, exposure to the elements, operation outside the placarded aircraft limitations and repairs attempted or made other than by **AIRBORNE** or its authorised agent, or as the case may be, the engine manufacturer.

**AIRBORNE** will replace free of charge any original part that is determined by it to be defective under the terms of this Warranty and reserves the right to pay monetary compensation or make good the defect in any manner it deems appropriate.

The customer is responsible for the transporting the aircraft or parts to and from **AIRBORNE** or its authorised agent when making claims under this Warranty. The aircraft or parts are at the customer’s risk whilst in transit to and from **AIRBORNE** or its authorised agent.

**NOTE:** Warranty service is available to the customer from **AIRBORNE WINDSPORTS PTY LIMITED** or any authorised agent provided the customer supplies this Warranty as proof of the delivery date of the aircraft.

CUSTOMER’S NAME \_\_\_\_\_

DATE OF DELIVERY \_\_\_\_\_

For and on behalf of  
**AIRBORNE WINDSPORTS Pty Ltd.** \_\_\_\_\_

© AirBorne WindSports Pty. Ltd.  
**PILOT HANDBOOK - EDGE SERIES MICROLIGHTS**

**1.7 Check List of Current Pages**

Ensure that your Aircraft Pilot Handbook is complete and up to date. When an amendment is affective, insert it in your copy and remove and destroy sheets that have been replaced. Ensure that your Aircraft Pilot Handbook is complete by comparing each sheet with this check list. Notify AirBorne WindSports of any discrepancies immediately.

Issue 1.7 EFFECTIVE 1 August, 2001

Page No	Issue	Date	Page No	Issue	Date
Cover Page	Issue 1.9	1 June 2003	Page 40	Issue 1.9	1 June 2003
Page 2	Issue 1.9	1 June 2003	Page 41	Issue 1.9	1 June 2003
Page 3	Issue 1.9	1 June 2003	Page 42	Issue 1.9	1 June 2003
Page 4	Issue 1.9	1 June 2003	Page 43	Issue 1.9	1 June 2003
Page 5	Issue 1.9	1 June 2003	Page 44	Issue 1.9	1 June 2003
Page 6	Issue 1.9	1 June 2003	Page 45	Issue 1.9	1 June 2003
Page 7	Issue 1.9	1 June 2003	Page 46	Issue 1.9	1 June 2003
Page 8	Issue 1.9	1 June 2003	Page 47	Issue 1.9	1 June 2003
Page 9	Issue 1.9	1 June 2003	Page 48	Issue 1.9	1 June 2003
			Page 49		
Page 10	Issue 1.9	1 June 2003	Page 50	Issue 1.9	1 June 2003
Page 11	Issue 1.9	1 June 2003	Page 51	Issue 1.9	1 June 2003
Page 12	Issue 1.9	1 June 2003	Page 52	Issue 1.9	1 June 2003
Page 13	Issue 1.9	1 June 2003	Page 53	Issue 1.9	1 June 2003
Page 14	Issue 1.9	1 June 2003	Page 54	Issue 1.9	1 June 2003
Page 15	Issue 1.9	1 June 2003	Page 55	Issue 1.9	1 June 2003
Page 16	Issue 1.9	1 June 2003	Page 56	Issue 1.9	1 June 2003
Page 17	Issue 1.9	1 June 2003	Page 57	Issue 1.9	1 June 2003
Page 18	Issue 1.9	1 June 2003	Page 58	Issue 1.9	1 June 2003
Page 19	Issue 1.9	1 June 2003	Page 59	Issue 1.9	1 June 2003
Page 20	Issue 1.9	1 June 2003	Page 60	Issue 1.9	1 June 2003
Page 21	Issue 1.9	1 June 2003	Page 61	Issue 1.9	1 June 2003
Page 22	Issue 1.9	1 June 2003	Page 62	Issue 1.9	1 June 2003
Page 23	Issue 1.9	1 June 2003	Page 63	Issue 1.9	1 June 2003
Page 24	Issue 1.9	1 June 2003	Page 64	Issue 1.9	1 June 2003
Page 25	Issue 1.9	1 June 2003	Page 65	Issue 1.9	1 June 2003
Page 26	Issue 1.9	1 June 2003	Page 66	Issue 1.9	1 June 2003
Page 27	Issue 1.9	1 June 2003	Page 67	Issue 1.9	1 June 2003
Page 28	Issue 1.9	1 June 2003	Page 68	Issue 1.9	1 June 2003
Page 29	Issue 1.9	1 June 2003	Page 69	Issue 1.9	1 June 2003
Page 30	Issue 1.9	1 June 2003	Page 70	Issue 1.9	1 June 2003
Page 31	Issue 1.9	1 June 2003	Page 71	Issue 1.9	1 June 2003
Page 32	Issue 1.9	1 June 2003	Page 72	Issue 1.9	1 June 2003
Page 33	Issue 1.9	1 June 2003	Page 73	Issue 1.9	1 June 2003
Page 34	Issue 1.9	1 June 2003	Page 74	Issue 1.9	1 June 2003
Page 35	Issue 1.9	1 June 2003	Page 75	Issue 1.9	1 June 2003
Page 36	Issue 1.9	1 June 2003	Page 76	Issue 1.9	1 June 2003
Page 37	Issue 1.9	1 June 2003			
Page 38	Issue 1.9	1 June 2003			
Page 39	Issue 1.9	1 June 2003			



**1.9 Table of Contents**

<b>1</b>	<b>PILOT HANDBOOK ISSUE DETAILS</b>	<b>2</b>
1.1	Warning Notice	2
1.2	Handbook Issue	2
1.3	Aircraft Details	3
1.4	Registration Details	4
1.5	Pilot Handbook Issue Details	4
1.6	Aircraft Warranty	5
1.7	Check List of Current Pages	6
1.8	Amendment Record	7
1.9	Table of Contents	8
<b>2</b>	<b>INTRODUCTION</b>	<b>10</b>
2.1	About this Handbook	10
2.2	Definitions and Abbreviations	11
<b>3</b>	<b>AIRCRAFT SPECIFICATIONS</b>	<b>12</b>
3.1	Aircraft Details	12
3.2	Power plant	13
3.3	Standard Instrumentation	14
3.4	Optional Instrumentation	14
3.5	Approved Wing and Trike Combinations	14
3.6	Three view drawing	15
3.7	Ground Turning Clearance	16
<b>4</b>	<b>OPERATING LIMITATIONS</b>	<b>17</b>
4.1	Airspeed Limitations	17
4.2	Weight and Loading Limitations	18
4.3	Power Plant Operating Limitations	19
4.4	Other Limitations	20
4.5	Aircraft Placards	21
<b>5</b>	<b>WEIGHT and BALANCE</b>	<b>29</b>
<b>6</b>	<b>EMERGENCY PROCEDURES</b>	<b>30</b>
6.1	Engine Failure on Climb Out	30
6.2	Engine Failure at Height	30
6.3	Full Power Engine Shutdown (In Flight)	30
6.4	Forced Landings	31
6.5	In Air Engine Fire	31
6.6	On Ground Engine Fire	31

**PILOT HANDBOOK - EDGE SERIES MICROLIGHTS**

6.7	Propeller Damage	32
6.8	Sail Damage	32
6.9	Emergency Parachute	32
6.10	Ignition Circuit Failure	33
6.11	Spins and Spiral Descents	33
6.12	Unusual Attitudes	33
<b>7</b>	<b><i>NORMAL PROCEDURES</i></b>	<b>34</b>
7.1	Preflight Inspections	34
7.2	Engine Fuelling, Starting and Control	36
7.3	Oil Injection Option	38
7.4	In Flight Procedures	38
7.5	Post Flight Inspection	43
<b>8</b>	<b><i>PERFORMANCE</i></b>	<b>45</b>
<b>9</b>	<b><i>AIRCRAFT and SYSTEMS DESCRIPTION</i></b>	<b>48</b>
9.1	The Streak Wing	48
9.2	The Wizard Wing	48
9.3	The Trike Unit	50
9.4	Power Unit	50
9.5	Electrical System	50
<b>10</b>	<b><i>AIRCRAFT HANDLING, SERVICE and MAINTENANCE</i></b>	<b>52</b>
10.1	Rigging Procedures	52
10.2	Derigging Procedures	54
10.3	Transportation and Storage	54
10.4	Assembly after Shipping	55
10.5	Maintenance Schedules	56
10.6	Engine Maintenance	62
10.7	Propeller Service and Adjustment	62
10.8	Airframe (Wing) Maintenance and Tuning	66
10.9	Tow Release Adjustment	70
<b>11</b>	<b><i>SUPPLEMENTS</i></b>	<b>71</b>
11.1	Rotax Engine Manual	71
11.2	BRS Emergency Parachute Manual	73

## **2 INTRODUCTION**

### **2.1 About this Handbook**

Dear Owner,

Congratulations on your purchase of a microlight aircraft from AirBorne.

Your new aircraft has been designed to provide you with many years of efficient, enjoyable flying and we are confident that it will.

As an Australian Company, we are proud of our range of microlight aircraft. Our microlights have been developed to provide the economy and durability required to meet the exacting demands of our Australian conditions.

The success of our microlights is based upon a high standard of product quality, innovative design engineering and exceptional standards of reliability and performance that have been established through the years.

AirBorne microlights are some of the most advanced microlights in the world, and meet the design requirements of Australian Civil Aviation Order (CAO) 95.32. Your microlight has been manufactured to very high standards but, in common with all aircraft, requires conscientious care and attention.

This handbook is designed to provide relevant information for safe operation. Please read this handbook carefully and maintain amendments to keep it up to date.

To help in obtaining satisfaction from your aircraft it is recommended that you return your aircraft for regular maintenance to the AirBorne Agent from whom it was purchased. If this arrangement is not practical or convenient arrange maintenance by the AirBorne Factory.

If the aircraft has been acquired from a private source, the factory should be contacted **immediately**. This will ensure that you receive updates for this handbook, and allow our Quality Assurance System to be adjusted.

AirBorne is very proud of the reputation our microlights have gained and we hope that you will come to share this pride.

In Australia, the Hang Gliding Federation of Australia (HGFA) and the Australian Ultralight Federation (AUF) administer Microlights.

To appreciate and enjoy your new microlight, please take time to read this handbook. The AirBorne Warranty Statement, aircraft specifications, service and maintenance procedures are detailed in this handbook.

The AirBorne Team has developed from the long-standing friendship of a group of enthusiasts who share conviction in the intrinsic advantages of weight shift controlled aircraft.

The AirBorne Team is confident your new microlight will provide you with many years of enjoyable flying, and we wish you and your family safe and happy flying for the future.

Amendments to this handbook may be necessary from time to time. An amendment record sheet is included for your use.

## **2.2 Definitions and Abbreviations**

In this handbook:

“**Airfield Pressure Altitude**” means the altitude of the airfield as indicated on an altimeter with the subscale adjusted to 1013.2 millibars or hectopascals.

“**AUF**” means the Australian Ultralight Federation.

“**AUW**” (All Up Weight) means the weight of the aircraft including occupants, fuel quantity, engine fluids, removable and disposable equipment.

“**CG**” means the Centre of Gravity.

“**fpm**” means feet per minute.

“**HGFA**” means the Hang Gliding Federation of Australia.

“**IAS**” means the airspeed indicated on the cockpit mounted airspeed indicator.

“**kg**” means weight in kilograms.

“**Landing Approach Speed**” means the airspeed that allows control in turbulence, wind gradient or sudden engine failure during landing.

“**Manoeuvring Speed**” means the indicated airspeed above which the pilot may not apply full, violent or coarse control movements.

“**Stall Speed**” means the indicated airspeed at which an uncontrolled downward pitching motion of the aircraft occurs or the control bar limit is reached.

“**Take Off Safety Speed**” means the airspeed that allows control in turbulence, wind gradient or sudden engine failure during the climb following take-off.

“**Trim Speed**” means the indicated airspeed at which the aircraft remains in a stabilised condition without pilot input.

“**V<sub>d</sub>**” means the aircraft design diving speed.

“**V<sub>NE</sub>**” means the indicated airspeed that the aircraft is never to exceed.

### 3 AIRCRAFT SPECIFICATIONS

#### 3.1 Aircraft Details

	<b>Trike Base</b>	<b>Streak Wing</b>	<b>Wizard Wing</b>
Rigging time	5 minutes	20 minutes	15 minutes
Wing weight		49 kg	47 kg
Trike empty weight from	118 kg (See Note 1)		
Aircraft total empty weight from		167 kg (See Note 1)	165 kg (See Note 1)
Max. take off weight	401 kg	401 kg	401 kg
Airframe	Aluminium Tube	Aluminium Tube multi-sleeved	Aluminium Tube multi-sleeved
Wing span		10.14 metres	9.96 metres
Wing area		15.0 square metres	16.8 square metres
Aspect ratio		6.6:1	5.6:1
Nose angle		130°	121°
No. of seats	2		
Fuel tank capacity Edge X	44 litres		
Minimum useable fuel Edge X Series	(See Note 2) 37 litres		
Maximum useable fuel Edge X Series	(See Note 3) 43 litres		
Fuel tank sump capacity Edge X Series	350 millilitres		

#### Notes

- 1 The weights shown are approximate and can vary according to the equipment fitted to the aircraft. See aircraft details at the front of this handbook for the weight of the aircraft to which this handbook applies.
- 2 The minimum useable fuel is defined by the first evidence of engine malfunctioning occurring at the full power setting, climbing at the safety take off speed with minimum aircraft weight. (see Section 8).
- 3 The maximum useable fuel is defined by the first evidence of engine malfunctioning occurring at the power setting established for level flight in the cruise configuration with maximum weight. (See Section 8)
- 4 For Aircraft Performance Data see Section 8.

©AirBorne WindSports Pty. Ltd.  
**PILOT HANDBOOK - EDGE SERIES MICROLIGHTS**

### 3.2 Power plant

Model	Rotax 503 - UL	Rotax 582 - UL
Displacement	497 cc	581 cc
Max Horsepower	49.6 HP @ 6500 rpm	64.4 HP @ 6500 rpm
Ignition System	Dual Ignition	Dual Ignition
No. of Cylinders	2	2
Carburettor	2xBing 36mm	Bing 54 Double Float
Fuel Grade	Unleaded Fuel (min. RON 90)	Unleaded Fuel (min. RON 90)
Fuel Mixture	50:1 - 2 Stroke (super 2-stroke oil, meet/exceed ASTM/CEC standard API-TC)	50:1 - 2 Stroke (super 2-stroke oil, meet/exceed ASTM/CEC standard API-TC)
Lubrication <sup>2</sup>	Oil-in-fuel mixture	Oil-in-fuel mixture
Cooling System	Air Cooled	Liquid cooling
Cooling System Capacity	Not Applicable	4 litres
Mixture Ratio		(50ml of inhibitor to 3.95 litres water)
Recommended Cooling System Additive	Not Applicable	Loctite All Seasons Radiator Care
Rotary Valve Oil Reservoir	Not Applicable	Fill to level indicator using Castrol TT oil
Approved Propeller / GearBox Combinations	C-Type (Reduction 2.58 : 1) AIRBORNE (IVO) 64" x 3 Blade Ground Adjustable . Pitch Setting 14 deg at blade tip	BorC Type (Reduction 2.58 : 1) AIRBORNE (IVO) 64" x 3 Blade Ground Adjustable . Pitch Setting 13 deg at blade tip
Gear Box Oil SAE 140 EP	C-Type (Reduction 3.00 : 1) AIRBORNE (IVO) 64" x 3 Blade Ground Adjustable . Pitch Setting 15 deg at blade tip	BorC Type (Reduction 2.58 : 1) GSC 66" x 3 Blade Ground Adjustable. Pitch Setting 15.5 deg at 600 mm from hub centre
C Type Qty 120 ml		
B Type Qty 300 ml	C-Type (Reduction 4.00 : 1) BROLGA 68" x 4 Blade Ground Adjustable . Pitch Setting 17 deg pitch blocks	C-Type (Reduction 3.47 : 1) BROLGA 68" x 4 Blade Ground Adjustable . Pitch Setting 17 deg pitch blocks

<sup>2</sup> Oil Injection Option, see ..

### **3.3 Standard Instrumentation<sup>3</sup>**

Altimeter, Airspeed Indicator, Hour Meter and Tachometer.

### **3.4 Optional Instrumentation**

Altimeter with sub scale, Exhaust Gas Temperature, Cylinder Head Temperature, Water Temperature and Compass. See Section 1.3 for details of instruments fitted with this aircraft.

### **3.5 Approved Wing and Trike Combinations**

The aircraft is **only** to be operated using the Airborne Wings and Trike units as detailed below. Only these combinations meet the requirements of the accepted Design Standards to which the aircraft complies.

<b>Trike Base</b>	<b>Streak Wing</b>	<b>Wizard Wing</b>
Edge 582 X Series	√	√
Edge 503 X Series	√	√

---

<sup>3</sup> Standard Instrumentation requirements vary from country to country. Refer to Section 1.3 Aircraft Details for a listing of factory fitted instruments for this aircraft.

### 3.6 Three view drawing

This drawing is representative only and is not intended to be used to identify the various configurations in which the aircraft is available.

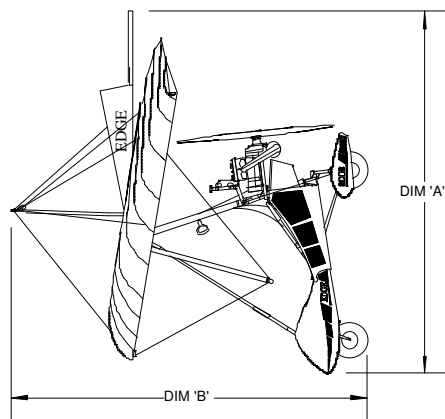
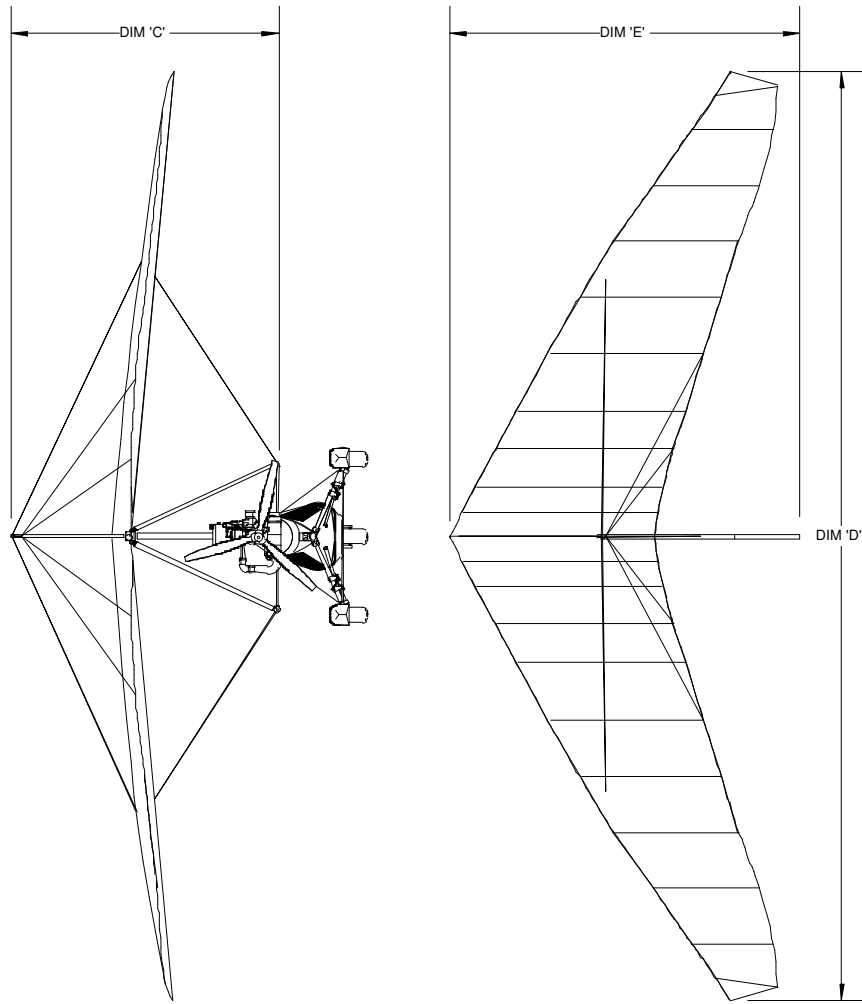

	EDGE WING	WIZARD WING	STREAK WING
DIM 'A'	3.995M	3.460M	3.500M
DIM 'B'	3.885M	3.600M	3.600M
DIM 'C'	2.930M	2.830M	2.830M
DIM 'D'	10.140M	9.960M	9.970M
DIM 'E'	3.812M	3.360M	3.200M

A4-2331.TCW

**3.7 Ground Turning Clearance**

	EDGE WING	WIZARD WING	STREAK WING
DIM 'F'	7 METRES	7 METRES	7 METRES
DIM 'G'	17.6 METRES	17.3 METRES	17.3 METRES

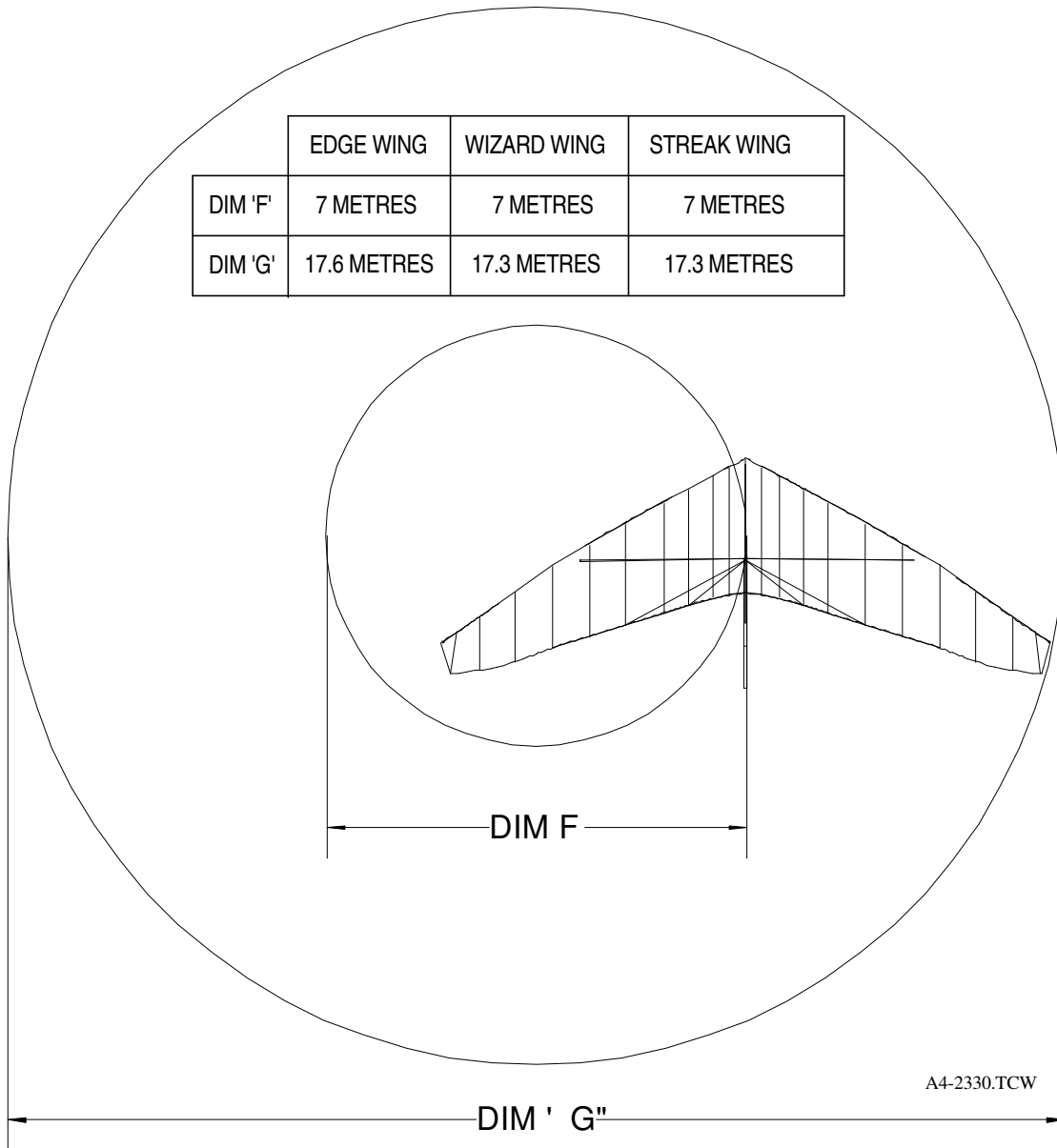

## 4 OPERATING LIMITATIONS

### 4.1 Airspeed Limitations

	Streak Wing (IAS)	Wizard Wing (IAS)
V <sub>ne</sub>	81 knots (93 mph)	54 knots (62 mph)
Manoeuvring speed	81 knots (93 mph)	54 knots (62 mph)
Trim Speed Fwd CG	45-55 knots (52-63 mph)	34-36 knots (39-41 mph)
Trim Speed Middle CG	40-50 knots (46-58 mph)	32-34 knots (37-39 mph)
Trim Speed Rear CG	35-45 knots (40-52 mph)	30-32 knots (35-37 mph)
Stall Speed (Power Off) Take Off Weight (250 kg)	24.0 knots (27.6 mph)	23.0 knots (26.5 mph)
Stall Speed (Power Off) Take Off Weight (340 kg)	29.0 knots (33.4 mph)	26.0 knots (29.9 mph)
Stall Speed (Power Off) Take Off Weight (401 kg)	34.0 knots (39.1 mph)	28.0 knots (32.2 mph)
Take Off Safety Speed & Nominated Approach Speed Take Off Weight (250 kg)	34 knots (39 mph)	31 knots (36 mph)
Take Off Safety Speed & Nominated Approach Speed Take Off Weight (340 kg)	39 knots (45 mph)	34 knots (39 mph)
Take Off Safety Speed & Nominated Approach Speed Take Off Weight (401 kg)	44 knots (51 mph)	37 knots (43 mph)
Maximum Level Speed	80 knots (92 mph)	50 knots (58 mph)
Max wind operating conditions (At ground level)	20 knots (23 mph)	20 knots (23 mph)
Cross winds of up to	11 knots (13 mph)	11 knots (13 mph)

## 4.2 Weight and Loading Limitations

	Streak Wing with Edge X Base	Wizard Wing with Edge X Base
Max number of occupants	2 persons	2 persons
Max empty weight Edge & Edge E series base	188 kg	188 kg
Max empty weight Edge X series base	191 kg	191 kg
Max take off weight	401 kg	401 kg
Max landing weight	401 kg	401 kg
Min total occupant weight	65 kg	65 kg
Max total occupant weight	180 kg.	180 kg
Max positive manoeuvring load factor	4.0 G	4.0 G
Negative load factors	Prohibited	Prohibited
Load factors below 1.0 G	To be avoided	To be avoided

The microlight aircraft must **only** be flown **solo** from the **front seat**. Minimum pilot weight flown solo should not be below 65 kg.

The approved combination of microlights are designed to carry a maximum cockpit weight of 180 kg with maximum fuel capacity of 44 litres (30.8 kg) for Edge X series bases.

Having the trike unit attached to the wing from a single universal bracket, variations of cockpit loading and fuel loading cannot influence the aircraft's balance. The Edge is therefore not critical in regards to centre of gravity although the distribution of load in the trike base effects the in-flight attitude of the trike base. This change in attitude of the trike base has a secondary influence on aircraft pitch control.

Edge series trikes should **only** be attached to the wing using the bracket and connecting bolt supplied. The bracket on the wings is designed with three trim settings allowing the trim to be preselected.

**The rear CG position must only be used with MTOW of less than 340 kg.**

**WARNING**  
**AT LOW ALL UP WEIGHTS, THE TAKE OFF CLIMB OUT AT THE TAKE OFF SAFETY SPEED CAN RESULT IN HORIZONTAL PITCH INCLINATIONS IN EXCESS OF THE PLACARDED 45 DEGREES MAXIMUM. THE PILOT MUST BE AWARE OF THIS AND SHOULD KEEP WITHIN THE PLACARDED LIMITATIONS BY LOWERING THE ATTITUDE OR REDUCING ENGINE POWER, JUST AFTER LIFT OFF.**

### 4.3 Power Plant Operating Limitations

The cockpit may be fitted with a cylinder head temperature gauge (CHT) and or an exhaust gas temperature (EGT) gauge. Aircraft fitted with the Rotax 582 water cooled engine may also have a water temperature gauge fitted.

The maximum operating temperatures are indicated by a **RED** mark on the gauge.

#### 4.3.1 Engine Cylinder Head Temperature Limitations

	503 UL	582 UL
Normal Operating Range	180 to 220 deg C 356 to 428 deg F	110 to 130 deg C 230 to 270 deg F
Maximum Operating Temperature	250 deg C 482 deg F	150 deg C 300 deg F
Difference between 2 Cylinders	20 deg C 36 deg F	10 deg C 18 deg F

#### 4.3.2 Engine Exhaust Gas Temperature Limitations

	503 UL	582 UL
Normal Operating Range	460 to 582 deg C 860 to 1080 deg F	500 to 620 deg C 930 to 1150 deg F
Maximum Operating Temperature	650 deg C 1200 deg F	650 deg C 1200 deg F
Difference between 2 Cylinders	25 deg C 45 deg F	25 deg C 45 deg F

#### 4.3.3 Engine Water Temperature Limitations

	503 UL	582 UL
Normal Operating Range	Not Applicable	60 to 80 deg C 140 to 180 deg F
Maximum Operating Temperature	Not Applicable	80 deg C 180 deg F

#### 4.3.4 Engine Tachometer Limitations

The instrument panel may be fitted with an engine tachometer gauge, and the operation of the engine rpm can be monitored using this gauge. The maximum rpm is indicated with a **RED** mark on the gauge.

	503 UL	582 UL
Engine Tachometer Limitations	6800 rpm Max	6500 rpm Max

If engine ground run tests are performed, it is important not to exceed the maximum rpm of the engine. The aircraft should be sufficiently secured (chocked) if full engine power is to be applied.

It is recommended for water-cooled models, that the engine not be run for any long periods whilst stationary on the ground. Possible damage to the engine may occur due to overheating of the engine coolant.

Most two-stroke engines are capable of starting up and operating backwards if ignition timing is incorrectly adjusted, has slipped, or is otherwise malfunctioning. It is therefore imperative that engine maintenance procedures for ignition timing are correctly conducted.

**UNDER NO CIRCUMSTANCES SHOULD THE ENGINE BE RUN WITHOUT THE SEAT FRAME HINGE POINTS IN THE LOCKED POSITION, AND THE FRONT SUPPORT TUBE CORRECTLY SECURED. THE ENGINE THRUST MAY COLLAPSE THE TRIKE UNIT INTO THE FOLDED POSITION.**

#### 4.4 Other Limitations

No person who is untrained or unqualified in weight shift controlled flight or, who is unfamiliar with the wing and base combination, should ever attempt to pilot the aircraft unless under professional instruction.

The aircraft is to be flown under visual flight rules (VFR), and the minimum equipment required to operate under VFR conditions are an Air speed indicator, Altimeter and an Engine Hourmeter.

The effect of light rain on the aircraft can increase the stall speed significantly. It is extremely important to maintain speeds in excess of the take off and landing safety speeds when the wing is wet. If the aircraft has been left out in the rain or heavy dew it is necessary to **wipe the wing** down prior to take off. It is also recommended that the aircraft be flown solo first to ensure all excess moisture is removed. A chamois or sponge is recommended to remove the water.

**THE STRUCTURAL FATIGUE LIFE OF THIS AIRCRAFT HAS NOT BEEN EVALUATED, AND AS SUCH, THE AIRCRAFT STRUCTURAL DURABILITY IS UNKNOWN.**

**MOISTURE ON THE WING CAN SIGNIFICANTLY INCREASE STALL SPEED AND SHOULD BE REMOVED PRIOR TO TAKE OFF.**

Heavy rain will cause the stall speed to rise to the point where it is possible to stall the aircraft without banking the wing. Under these circumstances the pilot input for control in the roll axis increases. Continued operation in heavy rain is not recommended due to the abrasive effect of rain drops on the propeller. Do not use waterproofing agents on the wing as the consequent beading of water droplets can significantly increase the stall speed.

Aerobatic manoeuvres including whipstalls, stalled spiral descents and negative “G” manoeuvres are **not permitted**. It must be emphasised that a whipstall, spiral descent or negative G manoeuvre can never be conducted safely. These manoeuvres put the aircraft outside the pilot’s control and puts both the aircraft and it’s occupants in extreme danger.

Do not pitch nose up or nose down **more than 45 degrees** from the horizontal. The fore and aft movement of the control bar is limited by the front support tube of the trike and the pilot’s chest respectively.

Do not **exceed 60 degrees** of bank angle. In the roll response there is no stop for the control movement. Freedom of movement for the preflight purpose is checked by lowering each wing to within 10 cm of the ground (on ground level).

©AirBorne WindSports Pty. Ltd.  
**PILOT HANDBOOK - EDGE SERIES MICROLIGHTS**

### 4.5 Aircraft Placards

The placards on the aircraft are designed to provide information regarding general aircraft limitations and other details for the safe operation of the aircraft.

Listed on the following pages are details of the placards fitted to the aircraft.

#### 4.5.1 Flight Limitations Placard

62mm

<b>AIRBORNE WINDSPORTS Pty. Ltd.</b> Newcastle, NSW, Australia			
AIRCRAFT TYPE		<b>EDGE</b>	
<b>FLIGHT LIMITATIONS</b>			
DO NOT PITCH NOSE DOWN OR NOSE UP MORE THAN 45 DEGREES FROM HORIZONTAL OR EXCEED 60 DEGREES OF BANK			
NO NEGATIVE G			
NO AEROBATIC MANOEUVRES			
NO WHIPSTALLS NO STALLED SPIRAL DESCENTS			
<b>ENGINE LIMITATIONS</b>			
FUEL/OIL MIXTURE RATIO	<b>50:1</b>		
MAXIMUM RPM			
CHT NORMAL (Deg C)			
CHT MAXIMUM (Deg C)			
<b>LOADING LIMITATIONS</b>			
<b>EMPTY WEIGHT</b>			
TRIKE BASE	EDGE WING	STREAK WING	WIZARD WING
kg	<b>53 kg</b>	<b>49 kg</b>	<b>47 kg</b>
TOTAL	kg	kg	kg
MAXIMUM TAKEOFF WEIGHT (kg)			
MAXIMUM WEIGHT OF OCCUPANTS	<b>180kg</b>		
FLY SOLO FROM FRONT SEAT ONLY			

PART No.103835

136mm

<b>Location</b>	The flight limitation placard is located on the trike base tube between the steering carrier and the rear passenger foot rest	
<b>Series</b>	Edge X	
<b>Configuration</b>	With Streak Wing	With Wizard Wing
<b>Placard</b>	103835	103283

© AirBorne WindSports Pty. Ltd.  
**PILOT HANDBOOK - EDGE SERIES MICROLIGHTS**

4.5.2 Wing V<sub>ne</sub> ASI Placard

<b>Location</b>	The wing Vne Placard is located on the Air Speed Indicator
<b>Series</b>	Edge X
<b>Configuration</b>	All
<b>Placard</b>	103906

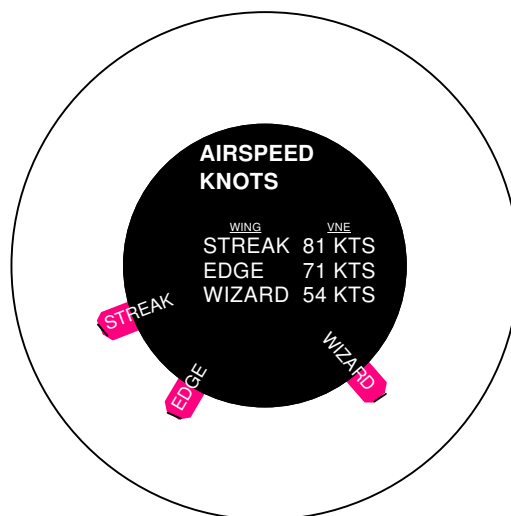

4.5.3 Wing Trimmer Operation Placard



The wing trimmer operation placard is fitted to Streak wings only. It is located on the control frame starboard down tube adjacent to the trimmer knob.

4.5.4 Take off Safety Speed Placard

52mm

TAKE OFF SAFETY SPEED				
	EDGE WING	STREAK WING	WIZARD WING	
30mm	250 kg	34KTS	34KTS	31KTS
	340 kg	38KTS	39KTS	34KTS
	401 kg	40KTS	44KTS	37KTS

INDICATED AIR SPEED SHOWN

PART No.103834

<b>Location</b>	The Take off Safety Speed Placard is located on the dash adjacent to the mast brace tube.	
<b>Series</b>	Edge X	
<b>Configuration</b>	With Streak Wing	With Wizard Wing
<b>Placard</b>	103484	103484

©AirBorne WindSports Pty. Ltd.  
**PILOT HANDBOOK - EDGE SERIES MICROLIGHTS**

4.5.5 Hang Glider Aerotow Limitations Placard

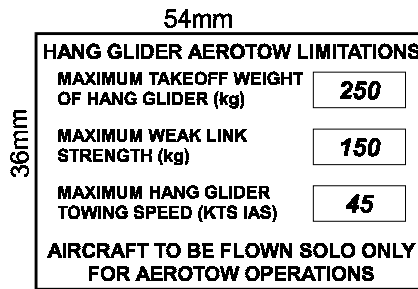

PART No.103281

<b>Location</b>	When a tow system is fitted the Hang Glider Aerotow Limitations placard is located on the dash adjacent to the mast brace tube.	
<b>Series</b>	Edge X	
<b>Configuration</b>	With Streak Wing	With Wizard Wing
<b>Placard</b>	103281	103281

4.5.6 Aircraft Type Approval Placard

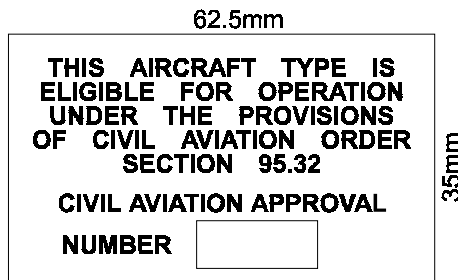

PART NO. 101172

<b>Location</b>	The Type Approval Placard is located on the trike base tube between the steering carrier and the rear passenger foot rest.	
<b>Series</b>	Edge X	
<b>Configuration</b>	With Streak Wing	With Wizard Wing
<b>Placard</b>	101172	101172

©AirBorne WindSports Pty. Ltd.  
**PILOT HANDBOOK - EDGE SERIES MICROLIGHTS**

4.5.7 Fuel Capacity Placard

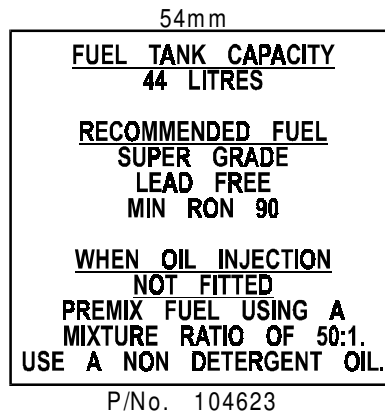

<b>Location</b>	The Fuel Capacity Placard is located on the fuel tank adjacent to the fill point.	
<b>Series</b>	Edge X	
<b>Configuration</b>	With Streak Wing	With Wizard Wing
<b>Placard</b>	103110	103110

4.5.8 Useable Fuel Placard

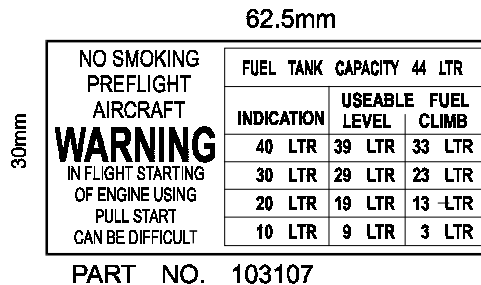

<b>Location</b>	The Useable Fuel Placard is located on the aircraft dash.	
<b>Series</b>	Edge X	
<b>Configuration</b>	With Streak Wing	With Wizard Wing
<b>Placard</b>	103107	103107

#### 4.5.9 Fuel Tap Placard

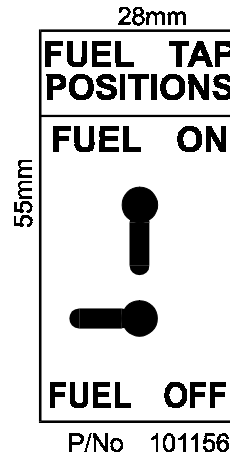

<b>Location</b>	<b>582 Edge X</b> The fuel tap placard is adjacent to the fuel tap at the front of the engine on the <b>starboard</b> side of the aircraft. <b>503 Edge X</b> The fuel tap placard is adjacent to the fuel tap at the front of the engine on the <b>port</b> side of the aircraft	
<b>Series</b>	Edge X	
<b>Configuration</b>	With Streak Wing	With Wizard Wing
<b>Placard</b>	101156	101156

#### 4.5.10 Hand Throttle Placard

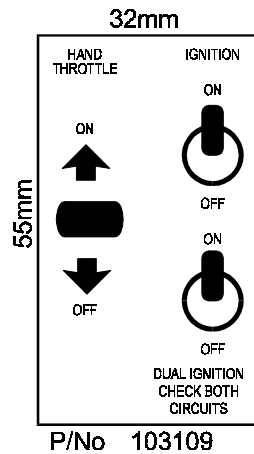

<b>Location</b>	The hand throttle placard is located on the starboard seat frame adjacent to the hand throttle lever.	
<b>Series</b>	Edge X	
<b>Configuration</b>	With Streak Wing	With Wizard Wing
<b>Placard</b>	103109	103109

4.5.11 Choke Placard

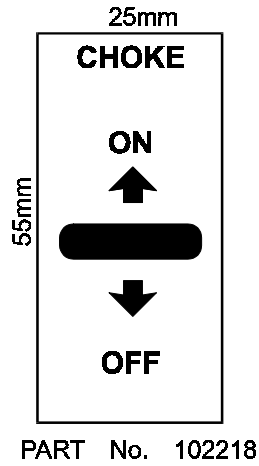

<b>Location</b>	The hand choke placard is located on the port seat frame adjacent to the hand choke lever.	
<b>Series</b>	Edge X	
<b>Configuration</b>	With Streak Wing	With Wizard Wing
<b>Placard</b>	102118	102118

4.5.12 Ignition Placards

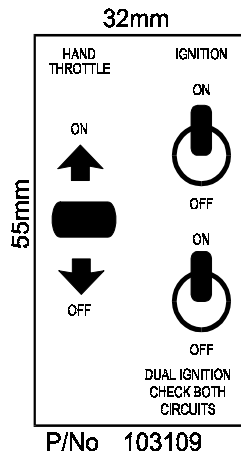

<b>Location</b>	The ignition placard is located on the starboard seat frame adjacent to the ignition switches.	
<b>Series</b>	Edge X	
<b>Configuration</b>	With Streak Wing	With Wizard Wing
<b>Placard</b>	103109	103109

#### 4.5.13 Earth Placard

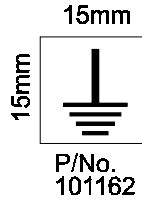

<b>Location</b>	The Engine Earth placard is located on the top seat frame on the starboard side	
<b>Series</b>	Edge X	
<b>Configuration</b>	With Streak Wing	With Wizard Wing
<b>Placard</b>	101162	101162

#### 4.5.14 Circuit Breaker and Power Socket Placard

The circuit breaker placard is fitted on the dash of Edge X-II series aircraft.

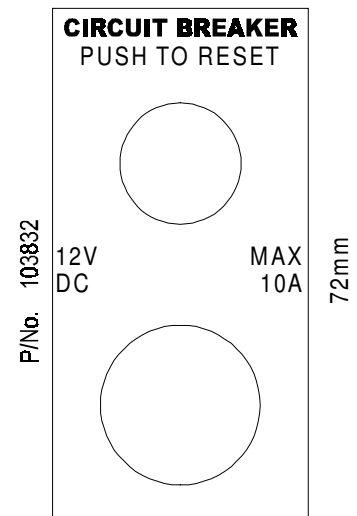

#### 4.5.15 Master Switch and Electric Start Placard

The electric start placard is fitted on the dash of Edge X-II series aircraft which have the electric start option fitted..

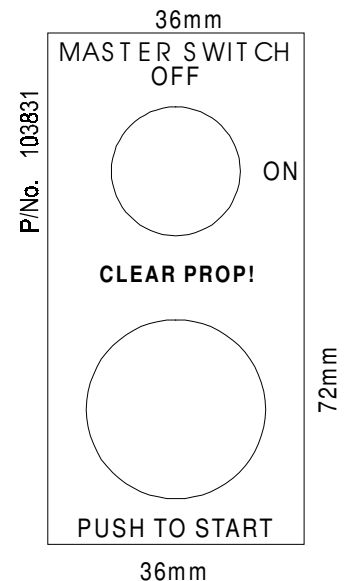

#### 4.5.16 No Step Placard

<b>Location</b>	The No Step Placards are located on the floor of the cockpit , one on either side of the base bar.	
<b>Series</b>	Edge X	
<b>Configuration</b>	With Binnacle	With Cockpit
<b>Placard</b>	Not Fitted	101152



#### 4.5.17 Step Placard



<b>Location</b>	The Step Placard is on the trike base tube at the hinge point for the rear foot rest	
<b>Series</b>	Edge X	
<b>Configuration</b>	With Streak Wing	With Wizard Wing
<b>Placard</b>	101159	101159

#### 4.5.18 Clear Prop Placard



<b>Location</b>	The clear prop placard is located on the fuel tank at the rear and to the top of the tank..	
<b>Series</b>	Edge X	
<b>Configuration</b>	With Streak Wing	With Wizard Wing
<b>Placard</b>	101154	101154

**5 WEIGHT and BALANCE**

This aircraft must only be flown solo from the front seat. No ballast is required if the pilot weight is above 65 kg. If the pilot weight is below 65 kg it may be necessary to carry ballast in water bags. Ensure the bags are watertight and safely secured in flight.

All aircraft operations may be carried out whilst solo, as when the aircraft is flown dual. With lighter aircraft A UW the full-power setting may have to be reduced to get a safe climb angle after lift off.

The wings have three attachment points on the universal bracket. The forward setting will increase the trim speed and the aft setting will decrease trim speed.

The variation of attachment point has been designed to allow the pilot to pre-select the centre of gravity position prior to flight.

Under normal operations the trike base should be attached to the wing in the middle position. The rearward trim position must be used with MTOW of 340kg or less. In flight the only noticeable difference is the control bar pitch pressure, which increases as the hang point is moved rearward.

The fuel capacity must always be considered when measuring the A UW of the aircraft. Remember that fuel is measured at 0.7 kg per litre and may slightly alter the aircraft's performance during take off and landing.

The table below are the minimum and maximum allowable CG range for AirBorne wings. The CG position should not be outside of these dimensions.

<b>WING CG RANGE - Measured from the line joining the leading edge nose bolts to the suspension point.</b>	<b>MAXIMUM REARWARD CG</b>	<b>MINIMUM FORWARD CG</b>
STREAK WING	1260 mm	1210 mm
WIZARD WING	1630 mm	1580 mm

## **6 EMERGENCY PROCEDURES**

This section contains operating procedures for flight and system emergency conditions that are essential for the continued safe operation of the aircraft.

Always maintain correct airspeed and altitudes in the circuit area.

Never fly in uncertain weather conditions and always fly within your proven ability. Be sure only to extend your capabilities under planned training situations.

Carry out safe airmanship whilst flying and be aware of possible emergency landing areas along your flight path. If possible check for these areas from the ground as you enter the airfield or flying site. This technique is for safety reasons as engines are susceptible to stopping, no matter how reliably manufactured or maintained.

Keep a good lookout for other aircraft, always be thoughtful and show your intentions. Demonstrate good airmanship always!

### **6.1 Engine Failure on Climb Out**

If your engine fails on climb out, maintain airspeed, reduce angle of attack and land straight ahead if possible. Proceed as follows:

- C** Maintain Control
- A** Maintain Airspeed - take off safety speed
- L** Forced Landing (straight ahead if possible)

### **6.2 Engine Failure at Height**

If the engine stops while operating at cruise or full power when the aircraft is well clear of the ground, check:

- C** Fuel Contents
- F** Fuel tap on
- I** Ignition on

If your engine fails in flight, do not attempt to restart the engine unless one of these items is found to be incorrect and is able to be rectified. Relax and maintain control whilst concentrating on correct forced landing techniques.

### **6.3 Full Power Engine Shutdown (In Flight)**

If the engine should jam at full throttle in flight proceed as follows:

- C** Maintain Control.
- H** Get Height. With engine at full power adjust height and ground position to improve the outcome of a forced landing.
- A** Increase Airspeed to keep the climb angle less than 30 degrees above the horizontal.
- I** Switch off Ignition.
- L** Prepare for forced Landing

**UNDER NO CIRCUMSTANCES SHOULD THE AIRCRAFT BE SLOWED BY RAISING THE NOSE PRIOR TO SWITCHING OFF THE ENGINE.**

## **6.4 Forced Landings**

Proceed as follows:

- C** Maintain **C**ontrol and airspeed - nominated approach speed
- T** Throttle Closed
- I** Ignition off
- F** Fuel tap off
- S** Seat belts tight
- H** Helmets tight
- L** Limbs (arms and hands) inside seat frame
- L** Carry out final approach and **L**anding as closely as possible to normal power off landing procedure.

## **6.5 In Air Engine Fire**

For fire occurring whilst in flight, the initial procedure would be to maintain control of the aircraft and evaluate the extent of the fire. This emergency is unlikely to occur but to avoid any further problems, use common sense and land the aircraft safely. Proceed as follows:

- C** Maintain **C**ontrol
- F** Fuel tap off
- T** Full **T**hrottle To exhaust engine system fuel as soon as possible and maximise slipstream to clear flames from passengers and airframe.

When fuel is exhausted then:

- I** Ignition off
- L** Forced **L**anding
- B** After landing release seat **B**elt
- P** Release **P**assenger seat belt
- E** Evacuate aircraft

## **6.6 On Ground Engine Fire**

For fire occurring whilst in motion on the ground proceed as follows:

- C** Maintain **C**ontrol
- S** Use remaining **S**peed to clear people, aircraft and buildings
- T** Throttle closed
- I** Ignition Off
- B** After stopping release seat **B**elt
- P** Release **P**assenger seat belt
- F** Fuel tap off
- E** Evacuate aircraft

### **6.7 Propeller Damage**

The indication of propeller damage is usually felt by extreme vibration and lack of thrust.

- C**      Maintain Control
- T**      Throttle closed
- F**      Fuel tap off
- I**      Ignition off
- L**      Forced Landing

**AT FULL ENGINE REVS THE TIP OF THE PROPELLER IS SPINNING AT SPEEDS IN EXCESS OF 650 KILOMETRES PER HOUR. EVEN SMALL OBJECTS CAN CAUSE SIGNIFICANT DAMAGE TO THE PROPELLER.**

This problem may be avoided if precautions are taken prior to take off. Inspect the strip or ground you are to use as your take off area for sticks, rocks or any debris that may be flicked up by the tyres and sucked through the propeller.

Ensure that all items carried by occupants (such as cameras and sunglasses) are secured so they are not able to come loose and pass through the propeller.

### **6.8 Sail Damage**

If you encounter damage to the sail cloth during flight, the first procedure is to maintain control of the aircraft. If the sail damage is not impairing the flight characteristics of the aircraft, land at the nearest landing field to inspect the damage.

### **6.9 Emergency Parachute**

The emergency ballistic parachute can be fitted as an option.

The parachute operating handle is fitted with a safety pin. This pin should be removed before each flight and the safety pin must be replaced before the pilot alights from the aircraft.

The parachute is only to be used in emergency situations when you are certain that:

- the aircraft has suffered structural damage to the extent that control is not possible; or
- if the aircraft is in an irrecoverable situation where structural damage is likely to occur.

**IT IS IMPORTANT TO REALISE THAT WHILST THE RATE OF DESCENT IS CONTROLLED BY THE PARACHUTE, THE PILOT WILL HAVE NO CONTROL OVER THE PLACE THE AIRCRAFT WILL 'LAND'.**

To operate the parachute pull the handle at least twenty centimetres for the parachute rocket projectile to be activated. The parachute will allow the complete aircraft to be lowered to the ground.

Proceed as follows:

- T**      Throttle closed
- I**      Ignition off
- S**      Seat belts tight
- P**      Check parachute Pin removed
- D**      Deploy parachute
- L**      Forced Landing

### **6.10 Ignition Circuit Failure**

The Rotax engine requires a short circuit on the ignition circuit to stop the engine using the ignition switches. If this circuit is broken the engine should be stopped by using full choke to flood the engine.

It is possible to starve the engine by switching the fuel tap off. This method is not as quick as using the chokes.

Do not restart the engine until the fault has been fixed.

### **6.11 Spins and Spiral Descents**

Deliberate spinning is prohibited.

A spiral dive may develop after a stall if the bar is maintained at the forward limit and a large roll rate is allowed to develop. If this condition is not corrected it will lead to large and increasing roll attitudes (beyond the 45 degree limit). Increasing attitude, increasing speeds and large control bar feed back forces will occur. Incipient spiral dives can be terminated at any time by rolling wings level. If the spiral dive is allowed to develop to extreme roll attitudes, recovery is expedited by relieving control bar forces before rolling wings level and recovering from high speed condition.

**DO NOT ATTEMPT TO SPIN THE AIRCRAFT.**

**SPIRAL DIVES SHOULD NOT BE ATTEMPTED.**

**DURING DESCENDING TURNS AIRCRAFT ATTITUDE MUST BE KEPT WITHIN PLACARDED PITCH, ROLL AND AIRSPEED LIMITS.**

### **6.12 Unusual Attitudes**

Unusual attitudes where the nose is raised or lowered more than 45 degrees from the horizontal are to be avoided. On recognising a situation where the aircraft is approaching these pitch angles proceed as outlined below.

#### **6.12.1 Nose High Attitude**

To recover from the situation where the nose of the aircraft is pitched up more than 45 degrees from the horizontal proceed as follows:

- H** Hold attitude - Do not attempt to pull control bar in
- P** Reduce **P**ower
- O** As energy dissipates the aircraft will rotate nose down - keep control bar **O**ut.
- P** once the attitude lowers level the wings and increase **P**ower to prevent over pitching.
- R** Recover from dive and **R**esume desired flight path.

#### **6.12.2 Nose Down Attitude**

To recover from the situation where the nose of the aircraft is pitched down more than 45 degrees from the horizontal proceed as follows:

- O** Raise attitude - push **O**ut.
- P** Apply **P**ower
- R** Recover from dive and **R**esume desired flight path.

## 7 NORMAL PROCEDURES

### 7.1 Preflight Inspections

The ultimate responsibility for determining whether the aircraft is in a safe condition to be flown is with **YOU** the pilot in command.

Pre-flights are your responsibility if you are the pilot in command. Unlike the highway, there is no place to pull over and remedy an unsafe problem once you are airborne.

#### 7.1.1 Wing preflight inspection

The design of the wing is such that junctions not open to view may be reached from zipped inspection panels. Start at the nose and move around the wing making the following checks.

Wing preflight inspection	Streak Wing	Wizard Wing
Nose catch secure and locked	√	√
Nose Cone Velcro aligned and secure	√	√
Leading-edge tubing undamaged	√	√
Cross-bar hinge junction secure	√	√
Centre undersurface zip secure	√	<b>N/A</b>
Sail tip secure and webbing not worn	√	√
Washout rod secure and undamaged	√	√
Batten elastics secure	√	√
Reflex Bridle lines secure	√	√
Cross bar tensioner secure	√	√
Velcro Pull Back cover aligned and secure	√	√
Hang-point / Universal bracket secure	√	√
Control frame locked	√	√
Control frame cables secure	√	√
Top rigging secure	√	√
All Inspection zips secure	√	√
Sail condition inspection	√	√
Sail free from water accumulation	√	√
General inspection of complete wing	√	√
Full/free movement of the wing when attached to the trike base.	√	√

©AirBorne WindSports Pty. Ltd.  
**PILOT HANDBOOK - EDGE SERIES MICROLIGHTS**

If the wing has been left fully set up for any period, then the following additional checks should be performed:

<b>Extended set up Wing preflight inspection</b>	<b>Streak Wing</b>	<b>Wizard Wing</b>
The symmetry of the wing (Batten profile check).	√	√
All tubes straight, undamaged and without cracks.	√	√
All cables undamaged, no fraying with secure thimbles/swages.	√	√
All nuts and bolts secure and locked appropriately.	√	√
All quick-release fittings secure.	√	√
Universal bracket undamaged, heart-bolt and back-up strap secure.	√	√
Sail tension settings correctly aligned and symmetrical	√	√
Battens undistorted, and in good condition	√	√
All sail seams intact, with no frayed stitching.	√	√
No tears or nicks in the sail.	√	√
Trimmer functional and wires not damaged	√	

<b>Areas of high stress to be checked include:</b>	<b>Streak Wing</b>	<b>Wizard Wing</b>
Both tip fabric areas including tip webbing.	√	√
Both leading edge upper surfaces.	√	√
At the nose of the wing check sail attachment area.	√	√
The trailing edge stitching, grommets, reflex tabs and batten elastics.	√	√
Keel fin pocket, particularly at the point of attachment to the upper surface.	√	√
Keel pocket to keel tube fastening.	√	√
The point of attachment in the root area of the undersurface to the upper surface.	√	√
All cable entry and exit points with particular regard to the upper rigging cable entry.	√	√
The area above the cross bar centre hinge box.	√	√

### 7.1.2 Trike Preflight Inspection

<b>Trike Preflight Inspection</b>	<b>503 UL</b>	<b>582 UL</b>
No leaks from fuel system and engine.	√	√
Fuel On/Off valve in the ON position.	√	√
Fuel filter clean and operational.	√	√
Fuel drain valve - check for any water in tank sump by draining a small quantity into a container	√	√
Sufficient fuel for flight.	√	√
Correct radiator water level.		√
Radiator hoses secure and operational.		√
Oil level for Rotary Valve feed.		√
No splitting, denting or delamination of the propeller.	√	√
No cracking in tyre treads, nor evidence of cracking around the rim.	√	√
Remove any grass build up on the lower axle cables.	√	√
No bolts bent, fractured or evidence of corrosion.	√	√
Electrical system secure and operational.	√	√
Throttle operation, both foot and hand throttle.	√	√
Seat belt attachments secure.	√	√
Steering damper - adjust to desired setting.	√	√
All engine components secure - air filter, muffler, plug leads.	√	√
Aerotow release is operational and correctly adjusted.	√	√
Aerotow release shaft bearing secure.	√	√
General inspection of complete trike.	√	√

### 7.2 Engine Fuelling, Starting and Control

Safety is everyone's business. Included are only some important safety tips. Keep a good lookout, be thoughtful and always show your intentions prior to starting.

The Rotax engine is a reliable and economical engine. With proper maintenance, care and the use of suitable fuel and oil, the engine should give you good service and reliability for many years.

**REMEMBER CLEAR PROP!**

Make sure all engine controls are operative and you understand the on/off positions of the throttle and ignition. These controls are readily accessible and you must be able to operate them instinctively without hesitation.

Maintain your engine in top condition and assume it's going to stop running at anytime. Leave yourself a way out for an unexpected engine failure.

Never run the engine on the ground with the propeller turning unless you are doing so in a run up area and can observe anyone or anything entering the danger area.

It is recommended for water-cooled models, that the engine not be run for any long periods whilst stationary on the ground. Possible damage to the engine may occur due to overheating of the engine fluid.

Never leave your aircraft unattended while the engine is running.

Keep an aircraft log and enter any unusual engine behaviour. Do not fly unless you have corrected a given problem and recorded the correction in the log.

Never fly your aircraft at locations, airspeeds, altitudes, or under any circumstances from which a successful engine off landing cannot be attempted.

Before starting your engine, read the engine manual in the Section 11.1 of this handbook.

The primary throttle control is foot-operated and complemented by the cruise control hand throttle (forward for full power and rearward for power off).

The ignition kill switches are on the right hand side of the seat frame. (Forward for on and rearward for off).

The engine pull start system is a pull start handle, running through a pulley on the main mast above and behind pilots head. The electric start system is activated by a push button on the right side of the dash.

### 7.2.1 Fuel

Fuel flow is from a single fuel tank fitted with a self-venting tube, and mounted around the monopole and below the engine.

The fuel system is fitted with a shut off valve. Be sure this valve is in the **ON** position before starting engine.

Super grade gasoline, (preferably without lead, min. RON 90), should be mixed with a super 2-stroke oil at a ratio of 50:1<sup>4</sup>.

2-stroke oil to meet or exceed ASTM/CEC standard API-TC.

A rule of thumb for fuel / oil mixture is;

Fuel quantity in litres, times two, and add a zero to convert to millilitres.

eg. 18 litres x 2 = 36 add 0 = 360 mls of oil.

Never refuel if fuel could be spilled on hot engine components. Use only safety approved fuel containers and never transport fuel in an unsafe manner.

The fuel tank has a water drain mounted at the base and to the rear of the tank. The fuel system has an in-line fuel filter, which is mounted at the front of the tank inside the rear of the cockpit. This filter can be easily disassembled for cleaning and inspection.

The Edge X series fuel levels are marked on the right side of the fuel tank. The fuel levels are marked at 10 litres, 20 litres, 30 litres and 40 litres.

Variations in trike base attitude under different flight conditions affect the quantity of fuel that can be drawn from the tank. Fuel level markings are shown for the aircraft parked on level ground. A similar trike base attitude can be obtained in flight by flying the aircraft at trim speed with the engine idling.

**NEVER ADD UNMIXED FUEL AND OIL TO THE TANK<sup>4</sup>. THE FUEL MIXTURE IS TO BE MIXED IN A SUITABLE CONTAINER FIRST. FILL THE CONTAINER WITH FUEL AND THEN ADD OIL. ALL FUEL SHOULD BE ADDED TO THE AIRCRAFT FUEL TANK WITH A FUNNEL FITTED WITH A WIRE STRAINER.**

**ENSURE THE AIRCRAFT IS EARTHED TO AVOID STATIC DISCHARGE IGNITING FUEL DURING THE REFUELLING OPERATION**

<sup>4</sup> Non oil injection models only, for oil injection see 7.3

## 7.2.2 Engine Starting

All controls should be checked with the ignition OFF. Passengers should have seat belts secure and be briefed for the flight.

The engine may be started with the pilot in the front seat. If this is not possible, the aircraft may be started externally.

**CHOCK THE AIRCRAFT TO REDUCE ANY POSSIBILITY OF DANGER TO ANY PERSON/S DURING ENGINE STARTING.**

- Check that the hand throttle is **OFF**. Unless the engine is hot, apply full choke.
- Check visually that the propeller area is clear and call **“Clear Prop”** out loud.
- Switch both ignitions **ON** when the area is clear, take hold of the starting handle, pull gently until it is felt to engage and lock, and then pull forcefully. Repeat until the engine starts.
- If the engine refuses to start switch off the ignition before investigation.
- When the engine starts, increase the engine RPM to a little above idle and release the chokes.
- Warm up the engine.
- Before flight a full-throttle check is to be carried out. During this operation the pilot must be seated in the cockpit and prepared to switch off the ignition at very short notice if an emergency should arise.
- The two ignition circuits should be tested with the engine running at 3000 rpm. Ignition one and two should be alternatively switched off. The RPM drop should not exceed 300 rpm.

## 7.2.3 Stopping the Engine

To stop the engine after a period of running, the ignitions should be switched off at idle. Switching off at high RPM floods the engine and makes restarting difficult. If the engine has been running under full power allow the engine to cool at a rpm setting just above idle, before switching off.

## 7.2.4 Cruise Control

The hand-operated cruise control should not be used during take-off and/or during landing.

In other cases of flight the engine rpm can be set with the cruise control lever and then the pressure on the foot pedal may be removed until an increase in rpm is required. After that, the rpm will always return to the cruise setting when foot pressure is removed. To obtain the full rpm range on the foot pedal, the cruise control lever must be in the off position.

## 7.3 Oil Injection Option

With oil injection option, use straight fuel into tank, (min. RON 90). Ensure sufficient oil in oil tank before starting. It is recommended to fill the first tank of fuel with gasoline oil mixture at a mixing ratio of 100:1. This is for safety until the system is properly filled with oil.

See Rotax Instalation Manual 12.0

## 7.4 In Flight Procedures

Information on the aircraft flight controls is detailed in this section, but it is mandatory that you receive professional training prior to any solo flight. It is illegal to operate this aircraft in Australia without a licence issued by the HGFA or AUF.

**NO ATTEMPT SHOULD BE MADE TO FLY THE AIRCRAFT WITHOUT APPROPRIATE WEIGHT SHIFT AIRCRAFT FLIGHT TRAINING WITH AN APPROVED INSTRUCTOR.**

### 7.4.1 Trim

Under normal operations the trike base should be attached to the wing in the middle position. The rearward trim position must only be used with MTOW of 340kg or less.

No ballast is required for single-seat use when the pilot weight is above 65 kg.

The Streak trimmer system allows in flight trim adjustment by rotating the trimmer wheel on the right downtube. Rotation of the trimmer wheel clockwise raises the reflex bridles causing extra reflex in the root section of the wing. This causes a reduction in trim speed of 5-10 knots. The swage on the trimmer wire is used as the reference position.

During take off and landing the trimmer should be completely off or a maximum of 50% on. The placard on the downtube adjacent to the trimmer knob indicates the trim position.

There is a slight increase in roll pressures as the trimmer is used to decrease trim speed.

The aircraft is designed to be stable at trim under all loads with a small increase in trim airspeed as the AUW is increased.

### 7.4.2 Pre flight Checklist

Run through the following checklist (pronounced “twimpfish”) prior to commencing taxiing for each and every flight.

- T** Throttle - full and free movement
  - Tyres - inflated and serviceable
- W** Wind - check direction and strength
  - Wires - secure and airworthy
- M** Mixture - chokes off
- P** Pins - fitted and secured
- F** Fuel - On and sufficient
- I** Instruments - check, set and operational
- S** Switches - ignition check (all switches on)
- C** Controls - pitch and roll - full and free movement
  - Chocks - removed (secured in aircraft)
- H** Harness and **H**elmet in place and secure

Remember that the pilot in command has the ultimate responsibility for the airworthiness of the aircraft in which he flies.

### 7.4.3 Take Off

AirBorne trike wings have a neutral static balance allowing a safe take-off that is controllable under all suitable flying conditions.

Refer to Section 8 for details of takeoff performance.

The take-off run is the measured ground distance covered until the aircraft reaches a height of 50 feet above the average elevation of the runway used.

These figures could be shorter if the take-off is from a tarmac, but longer if from wet ground. A significant headwind would reduce the length of the take-off run considerably.

Crosswind components of up to 11 knots at minimum AUW and 14 knots at maximum AUW are within aircraft operating limitations.

During the take-off run, the wing should be held in the trim position with the wings level. During take off and landing the Streak trimmer should be completely off or a maximum of 50% on. Accelerate smoothly to the take off safety speed. If the aircraft is fully loaded you will require full power.

When the aircraft reaches the takeoff safety speed the control bar should be pushed steadily forward until the trike lifts and rotates quickly on the main wheels. As the aircraft leaves the ground the control bar must be pulled back to maintain takeoff safety speed.

Lift-off depends on the all-up weight, ambient temperatures, airfield surface, wind gradient and other variables.

Climb out should be made on full power and with the control bar held in past trim speed to maintain the takeoff safety speed until a safe height has been reached. At this speed the aircraft would round out nicely into a glide should the engine fail.

When the desired flight altitude is reached the aircraft may be levelled out and throttle reduced to that required to maintain level flight.

Avoid pitching the nose of the wing up more than 45 degrees to the horizon. Very steep climbs are dangerous and can result in a stall followed by a severe pitching of the nose forward. Professional training is required for the correct procedures of unusual attitude recovery.

#### 7.4.4 Turns

Whether flown solo or dual, pitch control is very smooth, progressive and slightly damped, providing a positive “feel” always and in all manoeuvres.

Similarly, whether flown solo or dual, roll control gives no difficulty to even inexperienced pilots, being responsive, progressive, light and smooth.

With excellent roll rate the aircraft can be easily directed into a turn even at slow speeds. For a fast roll rate it is best to pull in for a little extra airspeed to initiate the turn.

Turns are initiated by lowering the nose slightly to increase airspeed, then by moving the trike in the required direction, slightly easing the nose up, and tightening the turn as the roll comes on. It may be necessary to apply a little power as you are turning to maintain your set altitude.

The wing will maintain a turn until the turn is removed by pilot input. Allow yourself plenty of margin for safety if you are practising any manoeuvres.

Do not fly slowly when practising low level operations and be certain of any power lines or obstructions in the operating area.

#### 7.4.5 Stalls

Refer to page 45 for details of stall speeds for various aircraft configurations.

In practice it is difficult to stall the aircraft in level flight. Stalling in turning flight is possible. The onset of stall is indicated by a significant increase in control bar loads.

Recovery from a mild stall is very gentle, whether with power is on or off. Recovery is immediate, with very little height loss there being no tendency to break away suddenly. A stall would have to be forced violently, to induce a danger.

When practising stalls make sure you have sufficient altitude. Push the control bar out so that the airspeed is reduced at 1 knot per second, and the aircraft will tend to mush without dropping a wing. The sink rate will increase in this mush mode more than two fold.

If the airspeed is decreased rapidly the nose will pitch higher. Hold the control out at this point and the nose will pitch down.

Never stall with the nose pitched up to high. This is a dangerous manoeuvre and can result in a tail slide followed by a severe tumble. As a guideline the angle at which the aircraft stalls is about the angle it will recover.

**HIGH-ANGLE CLIMB-OUTS NEAR THE GROUND SHOULD BE AVOIDED.**

**NEVER STALL THE AIRCRAFT WITH THE NOSE PITCHED UP TOO HIGH. THIS IS A DANGEROUS MANOEUVRE AND CAN RESULT IN A TAIL SLIDE FOLLOWED BY A SEVERE TUMBLE.**

**REFER TO PAGE 33 OF THIS FLIGHT MANUAL FOR DETAILS OF THE PROCEDURES FOR RECOVERY FROM UNUSUAL ATTITUDES**

#### 7.4.6 Spins

Deliberate spinning of the aircraft is prohibited.

**DO NOT ATTEMPT TO SPIN THE AIRCRAFT.**

Refer to Section 6.11 for recovery techniques for inadvertent spiral dives.

#### 7.4.7 The Effect of Engine Power

Control in the pitching axis is by shifting the weight relative to wing. Changes in thrust also react against the mass of the trike base. An increase in thrust pushes the trike base forward whilst a reduction in thrust allows the trike base to move aft.

To maintain a constant angle of incidence of the wing, when changing engine power, requires the pilot to compensate for this change in the position of the trike base relative to the wing.

There is no need to alter the bar position significantly if the power is adjusted smoothly as the pilot will tend to compensate automatically.

The effect of reducing power is to lower the nose of the aircraft and it is necessary to allow the control bar to move forward slightly to maintain a level flight.

An increase in power will cause the nose of the aircraft to pitch up tending to reduce airspeed. If the power is applied rapidly then the pilot may need to compensate for the change in pitch angle by pulling the control bar in until the airspeed has stabilised. Once stabilised you can then ease the control bar out to the desired airspeed.

#### 7.4.8 In Flight Engine Starting

Restarting the engine in flight using the pull start handle can be difficult. Do not stop the engine in flight unless it is an emergency or a suitable landing field is within gliding range.

#### 7.4.9 Stability

Stability is a notable feature of AirBorne designs. It is owed in part to the pendular weight distribution (which increases both stability and lightness of control as the trike weight is increased) and to the fully defined camber reflex section designed to give the wing inherent stability without reliance on the pendular loads.

#### 7.4.10 Landing

Landing should always be into wind with a long straight approach.

An approach to the airstrip may be made with or without power, but in either case the airspeed should be maintained above the nominated approach speed.

During take off and landing the trimmer should be completely off or a maximum of 50% on.

The aircraft should be flown on final approach at or above the nominated safety speed for the particular weight. The additional airspeed to allows for wind gradient, and to provide greater controllability in the rough air that may lie close to the ground.

Maintaining airspeed on final is very important for engine-off landings, allowing a margin for round out before touchdown.

The glide path can be controlled precisely with small variations of power. Excess airspeed decreases fairly quickly, so the ground effect is short and spot landings are accurate. The flare should be initiated at a low level, and there must be sufficient speed to ensure that the trike rotates into a nose-up attitude.

The trike is designed to land with the rear wheels touching down slightly before the nose wheel. Once firmly on the ground aerodynamic braking may be achieved by pulling in the control bar, then applying the front nose wheel brake.

New trike pilots should avoid landing in conditions with high cross wind components, as skills do not always match the capabilities of the aircraft. Crosswind landings with low wind components up to 8 knots, are quite safe and controllable, even to the inexperienced pilot.

After touchdown in cross wind conditions lower the upwind wingtip immediately and the undercarriage wheels will retain firm contact with the ground.

It must be noted that after a hard landing, your aircraft must be completely checked over.

### 7.4.11 Aerotow launch of Hang Gliders

Aerotowing hang gliders requires a higher level of skill and should only be attempted when an appropriate tug endorsement is achieved. All operations should be in accordance with the HGFA operations manual.

**AT NO TIME SHOULD AEROTOWING BE CONDUCTED WITH BOTH AN INEXPERIENCED TUG PILOT AND AN INEXPERIENCED GLIDER PILOT**

A rope length of 90 meters is recommended. A suitable rope is 6 mm polypropylene.

Weak links must be used on both the tug and the glider ends of the rope. The tug end weak link should be approximately 20% stronger than the glider end. Following is a guide for weak link strength:

Glider Take off Weight (Kg)	Glider Weak Link Breaking Load (kg)
70	50
130	90
190	130
250	150

#### A Preflight Check

- Check release operational and adjusted as shown on page 70.
- Check bearing collar is locked
- Ignition off when attaching rope
- Maximum weak link strength 150kg
- Maximum take off weight of hang glider 250 kg

#### B Takeoff

- Allow minimum airstrip length plus rope length
- Rope tensioned
- Full power
- Safety speed for appropriate take off weight

#### C Climb out

- Maintain safety speed for appropriate take off weight
- Maintain consistent airspeed and direction

#### D Turns

- Only shallow banked turns should be attempted
- Maintain consistent airspeed and direction

#### E Release

- Be familiar with the position of the release lever.
- The tug should break left when the glider pilot releases. The glider pilot will break right.

It is recommended that the rope be dropped adjacent to the airstrip prior to landing. However if conditions are suitable to keep the rope attached the tug pilot should be aware that the rope can catch on fences, trees etc

## 7.5 Post Flight Inspection

No flight is complete until the post-flight checks are finished. This has particular importance after a heavy landing.

### 7.5.1 Wing Post Flight Inspection

Start at the nose and move around the wing making the following checks.

Wing Post flight inspection	Edge Wing	Wizard Wing
Nose cone velcro aligned and secure	√	√
Nose catch secure and locked	√	√
Leading-edge tubing undamaged	√	√
Cross-bar hinge junction secure	√	√
Centre undersurface zip secure	√	N/A
Sail tip secure and webbing not worn	√	√
Washout rods secure and undamaged	√	√
Batten elastics secure	√	√
Reflex Bridle lines secure	√	√
Cross bar tensioner secure	√	√
Velcro Pull Back cover aligned and secure	√	√
Hang-point / Universal bracket secure	√	√
Control frame locked	√	√
Control frame cables secure	√	√
Top rigging secure	√	√
All Inspection zips secure	√	√
Sail condition inspection	√	√
General inspection of complete wing	√	√

In a hard landing causing damage of any significance, the complete aircraft should be checked by an Authorised agent.

### 7.5.2 Trike Post Flight Inspection

<b>Trike Post Flight Inspection</b>	<b>503 UL</b>	<b>582 UL</b>
No leaks from fuel system and engine.	√	√
Fuel On/Off valve in the OFF position.	√	√
Fuel filter clean.	√	√
Correct radiator water level.		√
Radiator hoses secure.		√
Oil level for Rotary Valve feed.		√
No splitting, denting or delamination of the propeller.	√	√
No cracking in tyre treads, nor evidence of cracking around the rim.	√	√
Remove any grass build up on the lower axle cables.	√	√
No bolts bent, fractured or evidence of corrosion.	√	√
Electrical system secure.	√	√
Throttle operation, both foot and hand throttle.	√	√
All engine components secure - air filter, muffler, plug leads.	√	√
General inspection of complete trike	√	√

In a hard landing causing damage of any significance, the complete aircraft should be checked by an Authorised agent.

## 8 PERFORMANCE

		503-UL				582-UL			
		Streak Wing		Wizard Wing		Streak Wing		Wizard Wing	
		Min Weight	Max Weight	Min Weight	Max Weight	Min Weight	Max Weight	Min Weight	Max Weight
V <sub>ne</sub>	knots	81	81	54	54	81	81	54	54
	(IAS) mph	93	93	62	62	93	93	62	62
Manoeuvring speed	knots	60	60	54	54	60	60	54	54
	(IAS) mph	83	83	62	62	83	83	62	62
Trim Speed	knots	40-50	40-50	30-36	30-36	40-50	40-50	30-36	30-36
	(IAS) (Middle Hole) mph	46-58	46-58	35-41	35-41	46-58	46-58	35-41	35-41
Stall Speed	knots	23	30	23	30	23	30	23	30
	(IAS) Power Off mph	27	35	27	32	27	35	27	32
Take Off Safety Speed	knots	35	45	31	37	45	50	31	37
	(IAS) mph	40	52	36	43	52	58	36	43
Nominated (IAS) Approach Speed	knots	45	50	31	37	45	50	31	37
	mph	52	58	36	43	52	58	36	43
Maximum Level Speed	knots	75	80	50	50	75	75	50	50
	(IAS) mph	86	92	58	58	86	86	58	58
Cross winds of up to	knots	11	14	11	14	11	14	11	14
	mph	13	16	13	16	13	16	13	16
Climb Rate at take off safety speed	fpm		447		430		717		525
Cruising Speed	knots	60	65	40	45	60	65	40	45
	(IAS) Fwd CG mph	69	75	46	52	69	75	46	52
Sink at cruising speed	Rate fpm		1184		450		1184		450
	Sink Rate at V <sub>ne</sub> fpm		2355		904		2355		904
Glide Ratio (engine off)		11:1	11:1	10:1	10:1	11:1	11:1	10:1	10:1

© AirBorne WindSports Pty. Ltd.  
**PILOT HANDBOOK - EDGE SERIES MICROLIGHTS**

	503-UL				582-UL			
	Streak Wing		Wizard Wing		Streak Wing		Wizard Wing	
	Min Weight	Max Weight	Min Weight	Max Weight	Min Weight	Max Weight	Min Weight	Max Weight
Take Off Distance metres (See Note 1)		260		220		218		240
Landing Distance metres (See Note 1)		228		210		228		210
Min airstrip length metres		364		310		305		340
Max wind knots	20	20	20	20	20	20	20	20
operating conditions (at ground Level) mph	23	23	23	23	23	23	23	23

## PILOT HANDBOOK - EDGE SERIES MICROLIGHTS

Note 1:

The  $V_{ne}$  specified can be achieved in aircraft operating at high all up weights. For aircraft operating with low weight it may not be possible to achieve this speed with the control bar pulled in against the pilots chest. Operation of the aircraft at speeds in excess of the Maximum level speed may require pitch control forces in excess of 20 kilograms.

Note 2:

Refer to Section 7.4.5 for information on stall characteristics.

Note 3:

Take-off and landing distances were established under test conditions of maximum take-off weight and no wind on a level dry grass surface at sea level. The distance shown represents that required to reach an altitude of 50 feet above the airfield at take off safety speed. Actual takeoff distances are significantly influenced by:

**TAKE OFF AND LANDING DISTANCES MUST BE INCREASED BY 20% FOR EACH 1000 FEET OF ALTITUDE ABOVE SEA LEVEL.**

- take-off weight;
- wind speed and direction at ground level;
- wind gradient close to the ground;
- turbulence,
- runway surface and slope;
- take-off altitude;
- air temperature; and
- pilot technique.

Always exercise judgement when selecting locations for take-off and landing. Leave adequate margin for appropriate control action in the event of sudden engine failure or turbulence being encountered.

## **9 AIRCRAFT and SYSTEMS DESCRIPTION**

### **9.1 The Streak Wing**

The Streak is a high performance “Keel-pocket-less” wing designed for a microlight. The principal elements of a wing airframe are shown in the sketch on the following page.

The keel and cross tubes are totally enclosed in the double surface. With the keel running parallel to the relative airflow, a decrease in drag is achieved. More importantly it enables the trike to be suspended from the aerodynamic centre of the wing giving greater roll and pitch authority. The Streak is light and predictable in both the roll and pitch axis.

The hang-point at which the trike is attached to the wing may be selected from one of three positions. This facility coupled with the in flight trimmer allows a wide trim speed range. The Streak has the ability to get you there very fast whilst maintaining the ability to land in the tightest of landing areas.

The sail design of the Streak has been tediously fine tuned to ensure that the sail maintains a constant airfoil over the speed range. The result is a very stable wing with exceptional controllability.

The multi sleeved leading edge construction is 63.5, 60.0 and 57.0 mm tube. This large diameter construction designed along with the sail luff curve, acts to preload the leading edge and maximise trailing edge tension throughout the speed range.

The sail is constructed using latest technology from the sail making industry. The leading edge and main sailcloth is 6 oz Dacron with a Mylar insert in leading edge pocket. A trailing edge band provides minimum stretch when loaded that not only gives long sail life, but also improves the top speed by controlling twist.

The Streak wing has been load tested in excess of 2450 kg. Excellent engineering contributes to the relatively lightweight of 49 kg.

The Streak wing is one of the easiest to set up high performance wings on the market. Quick clips and a 2:1 mechanical reduction on the pull back system significantly reduce the set up time and effort.

### **9.2 The Wizard Wing**

The Wizard is a 40 % double surface wing designed for the first time pilot through to the most experienced pilot who just wants to have fun. The design concept of the Wizard wing was simple. The wing had to be easy to fly and land, easy to pack up and easy to transport. The wing needed to be as light as possible without compromising structural integrity. We believe that we have succeeded in all aspects of the design.

Take off with the Wizard wing is easy. The control bar is positioned at trim and the trike will accelerate with very little input required by the pilot. The Wizard is a well-coordinated wing with smooth and predictable “feed back” given to the pilot. Control pressures are light whilst retaining a stable feel. The airfoil and sail design of the Wizard produces a gentle stall with unsurpassed stability in turbulence.

A minimum amount of battens are used consistent with maintaining airfoil definition. This coupled with quick clip cross bar retainer has resulted in a fast set up time. Improved engineering of the airframe has resulted in a 10% reduction in wing weight whilst maintaining the ability to carry 430 kg take off weight. The Wizard wing has been load tested in excess of 2300 kg.

The Wizard is a great all round wing with good all round performance, pleasant handling whilst retaining the ability for cross-country flying.

### 9.2.1 Wing Components

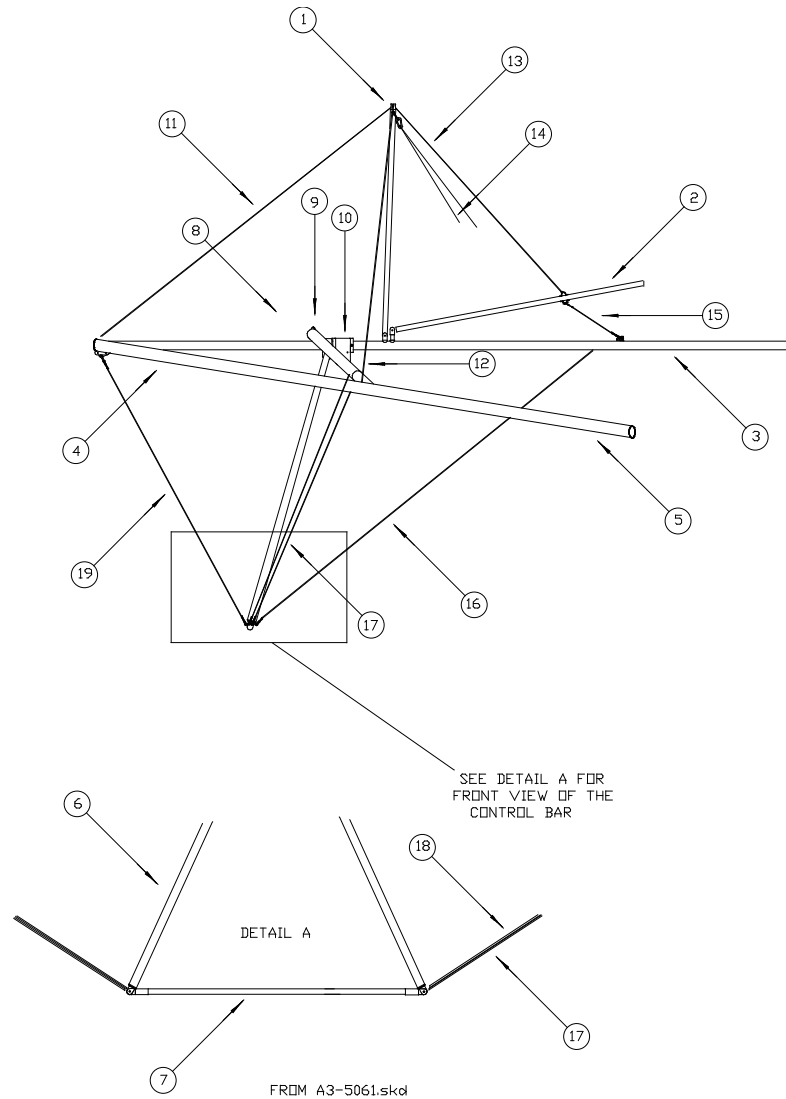

Identification of Principal Airframe Elements			
1	King Post	8	Cross Bar
2	Fin Tube (Edge wing only)	9	Cross Bar Hinge Junction
3	Keel	10	Universal Joint
4	Front Leading Edge	11	Top Front Wire
5	Rear Leading Edge	12	Top Side Wire
6	Down Tubes	13	Top Rear Wire
7	Control Bar	14	Reflex Bridle
		15	Fin Wire (Edge wing only)
		16	Bottom Rear Wire
		17	Bottom Aft Side Wire
		18	Bottom Forward Side Wire
		19	Bottom Front Wire

### **9.3 The Trike Unit**

Attached to the wing by way of a universal joint is the trike base. The universal joint allows the free movement of the trike base in pitch and roll by which control is effected. The trike base includes the characteristic tricycle undercarriage, power plant and cockpit.

A Rotax engine is mounted top and bottom on a chrome-molybdenum steel platform. A long-range fuel tank is mounted beneath the engine platform.

The pilot cockpit is designed to allow for various size pilots. The dash allows for a variety of instruments. Standard instruments for Australian certification include:

- Hourmeter;
- Altimeter;
- Air speed indicator and
- Tachometer

Optional instruments can also be added including:

- Head temp;
- Exhaust gas temp;
- Water temp;
- Compass and
- Altimeter with sub-scale

The cockpit version has soft sides attached to the pod and encloses the trike base tube and most of the fuel tank. Pockets in the soft sides allow for storage of small items such as intercom battery, and intercom / VHF radio control and other small items. A binnacle version is also available.

Other features available on the trike are aerodynamic rear wheel spats and adjustable steering dampener. Standard features include, rear wheel suspension, upholstered dual seat, front brake and 6" alloy wheels.

The maximum tyre pressure is 30 psi (205 kPa) and optimum pressure for general operations is 16 psi (110 kPa).

### **9.4 Power Unit**

The power unit is a Rotax engine designed and built in Austria. The Rotax engine is fitted with a gear box which delivers smooth thrust via a reduction drive. This power unit is complemented with a ground adjustable propeller giving the ultimate in performance and reliability. The engine is fitted with Bing 54 carburettors with an external dry filter.

### **9.5 Electrical System**

An electrical schematic for the aircraft is shown in the diagram on the following page.

The Electrical circuits comprise:

- an instrumentation circuit. The 12 V DC supply is protected by a 20 amp fuse at the battery and a 10 amp circuit breaker mounted on the dash. The master switch on the dash, when in the off position, disables the DC power socket, water temperature and the electric start push button;
- an engine temperature instrument circuit; and
- an ignition circuit.

It should be noted that the ignition circuit is a fail-safe system whereby the engine will run in the event of the ignition circuit becoming disconnected. Switching the coil to ground stops the engine.

When stopping the engine both switches on the side of the seat should be switched off. The master switch on the dash should then be turned to the off position to remove supply to the accessories.

If necessary the motor can be stopped using the chokes as detailed on page 33 of this handbook  
Refer to the Rotax manual for more details of the electrical system for the engine.

© AirBorne WindSports Pty. Ltd.  
**PILOT HANDBOOK - EDGE SERIES MICROLIGHTS**

*Electrical Schematic for Aircraft fitted with Rotax 503 & 582 U/L Engine.*

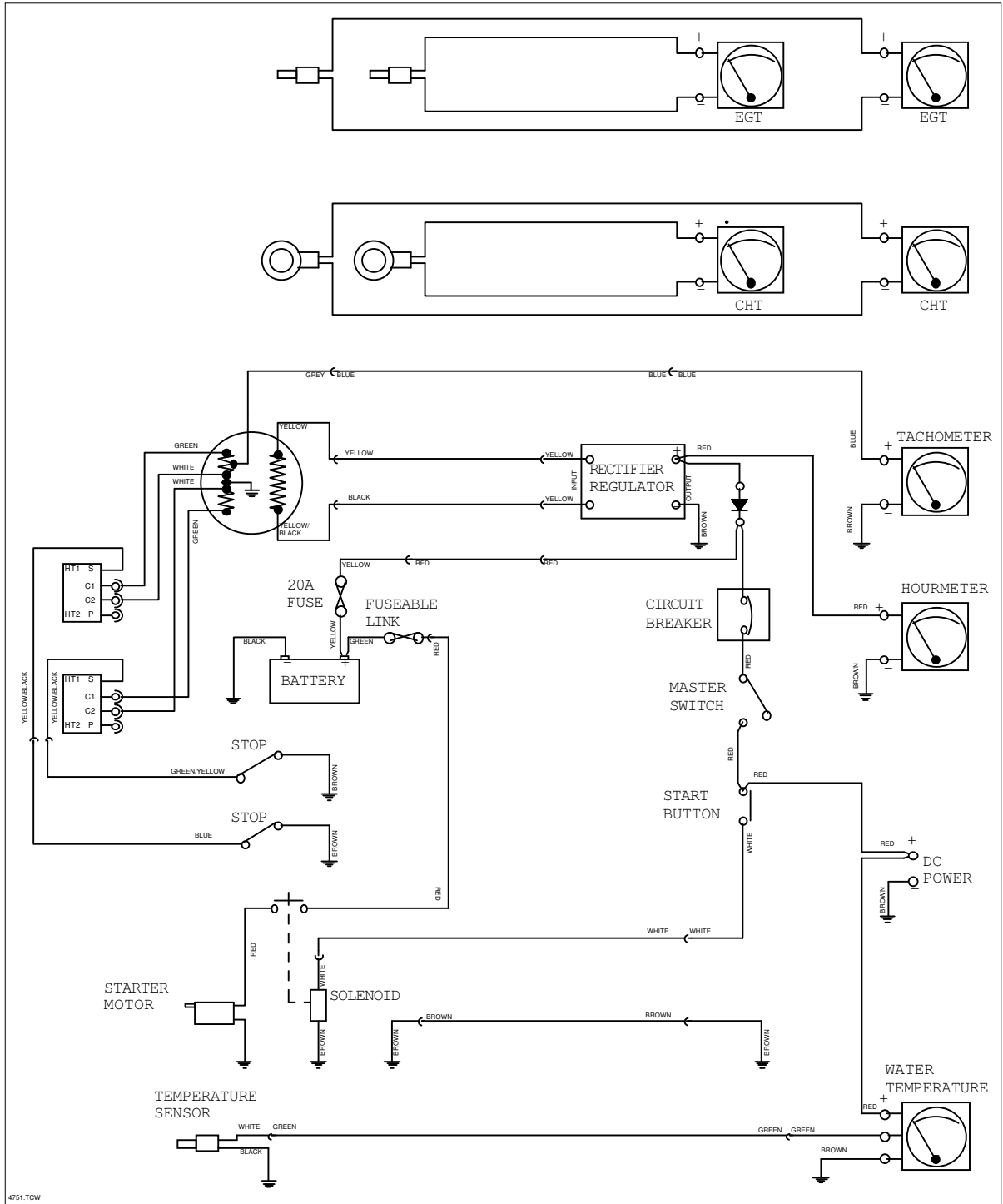

## 10 AIRCRAFT HANDLING, SERVICE and MAINTENANCE<sup>5</sup>

### 10.1 Rigging Procedures

#### 10.1.1 Wing Assembly Procedure

AirBorne trike wings should be assembled standing on the control frame. Assembling the wing on the control frame keeps the sail up off the ground and is less prone to being soiled or damaged. The suggested assembly procedure is as follows:

Wing Assembly Procedure	Streak Wing	Wizard Wing
Lay the wing down, zip up with the nose facing approximately 120 degrees from the wind direction. Unzip the bag but do not completely remove it from the wing.	√	√
Spread the control bar down tubes out and insert the base bar onto the alloy knuckle. The bolt is then inserted facing forward with the nut and pin firmly secured. Check that all the rigging wires are outside the control frame.	√	√
Rotate the complete wing and control frame 180 degrees to the vertical position, so that the wing is resting on the control bar. Do not attempt to connect the nose catch now.	√	√
Remove the glider bag and unclip all the ties.	√	√
Carefully spread both leading edges out half way then spread them both out to the approximate flying position. It is essential that the keel and the leading edges are kept in the same plane or damage will result.	√	√
Remove king post base padding and plug the kingpost into the socket on the keel. Make sure that the cross bar wires are not twisted and are on either side of the king post. Attach the reflex bridles.	√	√
Remove the battens from the bag. Place the ‘red’ battens in the left wing, and the ‘green’ battens in the right. Insert the top surface battens except for the last three tip battens starting with the battens closest to the keel.	√	√
The battens are inserted into the pocket with gentle pressure until they meet resistance. The wash out strut should now be located.	√	√
When securing the battens ensure the ends are properly located in the batten pockets.	√	√
The crossbars are now tensioned by pulling the wires (use webbing handle for Streak) until the cross bar shackle is located on the quick clip block. Install the Velcro Pull Back cover..	√	√
The nose catch should be now attached so that the pip pin is inserted through both the nose catch and channel.	√	√
Insert the nose batten tail end first and locate it on the fitting on the front of the keel.	√	√
Attach the nose fairing by applying the top Velcro first then gently tension over the nose plates and attach the Velcro to the undersurface.	√	√
Insert remaining tip battens and tip strutt. Check all zips are closed.	√	√
Insert undersurface battens	√	N/A

<sup>5</sup> This section of the pilot handbook includes maintenance details for aircraft options that are yet to be approved

You are ready for the wing pre-flight inspection. It is imperative that you carry out this inspection every time you rig and before you fly.

### 10.1.2 Trike Assembly Procedure

Pilots should inspect their machines as they rig them, paying attention to the following:

- Cables / kinks, missing or damaged thimbles, broken strands.
- Tubes / bends, stress marks, cracks around holes.
- Steel components / bends, rust, fractures.
- Moving Parts, seizure.
- Engine / bolts, throttle cables, seizure of carburettors.

### 10.1.3 Attaching Wing to Trike

Attaching Wing to Trike	Streak Wing	Wizard Wing
Move the propeller to a position where the keel can sit in the vee of the propeller hub.	√	√
Position the wing on its control frame, facing into the wind, with the nose on the ground. With the mast tube of the trike folded down, and with the ignition switch checked off, wheel the trike behind the wing, rolling the front wheel over the control bar.	√	√
Lift the main tube high enough to connect the universal junction on the wing, and secure with the bolt, wing nut and safety pin. There are three holes at the hang-point, which allow you to preselect trim. For general operations the centre hole should be used. If embarking on a long cross-country flight or carrying a high AUW, the front position may be selected.	√	√
Connect back up loop so that it passes over the keel and back to the mast.	√	√
Go to the nose of the wing, then rotate the wing about the control bar until the rear of the keel rests on the keel buddy or the vee of the propeller hub. In strong winds maintain a firm grip on the wing.	√	√
Lift the wing by the control bar, and once the wing is up in position, push down the seat frame hinges.	√	√
Fit the front support compression tube and secure with the pip pins to each tube.	√	√
The last action should be to chock the aircraft and secure the control bar with a strap, a sufficient measure in light winds.	√	√

(This simple method of attaching the wing to the trike single-handed or with assistance will be demonstrated by the agency delivering the aircraft).

### 10.1.4 Seat Operation

The front seat back on the Edge X trike has a simple for and aft adjuster on the base tube. To adjust the seat backrest forward the following procedure should be adopted:

- 1) Unclip soft side from pod
- 2) Remove pin and bolt from channel.
- 3) Rotate seat back forward and replace bolt in channel one hole further forward.
- 4) Replace safety pin through bolt.
- 5) Re fasten soft side to pod.

To move back rest rearward the bolt should be moved one hole back.

When flying the trike solo it is important to fasten the rear shoulder restraints to prevent contact with hot engine components in flight.

### 10.2 Derigging Procedures

Careful attention to the recommended rigging and derigging sequences will protect the wing from the risk of unnecessary damage.

The de-rigging procedure is a direct reversal of that for rigging; as with the preparation before flight the pilot should carry out an inspection.

- 1) Remove pip pins from the front support compression tube.
- 2) Lower the wing until the control bar is on the ground. Unbolt the trike from the hang-point, remove safety loop and wheel out the trike unit.
- 3) After detaching the wing from the trike, reverse the procedures listed in Section 10.1.1.
- 4) When preparing the wing for storage in the bag, roll the wing fabric carefully, ensuring that the protection patches are correctly positioned at the abrasion points.
- 5) Rigging cables should be placed neatly towards the nose of the wing ensuring none of the wires are kinked.

If it is intended to lay the wing flat on the ground ensure that the U bracket on the keel is well clear of the A-Frame as the wing is lowered.

### 10.3 Transportation and Storage

The wing must always be transported inside its bag, and the bag zip must face downwards to prevent the entry of rainwater. During transportation, or when stored on slings, the wing must be supported at its centre and at two points not more than one metre from each end. The padding supplied with the wing must be used to prevent chaffing during transport.

Supports should be softly padded, and any support systems used for transport, such as roof racks, must use attachment straps that are sufficiently secure to eliminate the possibility of damage from vibration and abrasions.

Avoid damage to your wing by using well padded racks. As the wing is quite heavy a strong set of racks are required. Flat straps should be used for tie downs to avoid damage to leading edge Mylar.

When transporting the trike base the use of trike and prop covers to protect your aircraft from road grime (and idle fingers) is recommended. Tie the propeller to the trike to stop it from rotating at speed.

Check that the back of the wing is well clear of the front mast with the trike on the trailer. Remember that you have an overhanging load when manoeuvring in tight places.

Store the wing in a dry room off the ground, air the wing out regularly to avoid mildew, and never store wet.

See your Rotax Manual for precautions to be observed if you intend to store the aircraft without use for extended periods.

## **10.4 Assembly after Shipping**

### **10.4.1 Trike Base Assembly**

Remove the strapping and discard the cardboard, remove parts and discard packing materials.

Attach a lifting device between the rear of the trike base and the top of the crate. Remove the bolts from the triangular rear support.

Raise the trike to a height to enable the landing gear to be attached. Insert bolt through strut and plates. Do not tighten the nuts at this point.

Attach the drag links ensuring they pass through the holes in the soft sides.

Lower the trike onto the undercarriage. Attach side wires to the mast. Attach soft sides to cockpit. Feed top soft side webbing under the rear engine mount. Ensure the webbing is routed over the cables and fuel line.

Remove front mast from crate support. Remove top of crate and vertical legs of crate.

Raise mast and roll trike clear of the trike base.

Tighten all nuts. Check the soft sides have not fouled on any control cables or fuel lines.

Attach the propeller and torque to the manufacturer specifications outlined in the manual.

Preflight the trike as described in the manual paying particular attention that there are no restrictions to cables or fuel lines

### **10.4.2 Wing Assembly**

Remove wing from box

Unzip bag and remove ties. Remove all padding from the tube ends.

Assemble the control frame. Rotate the glider on to the control bar, lying flat on the ground.

Spread both leading edges approximately ½ meter. Remove the tip bags, which have been used as protection on the rear of the front leading edges.

Insert rear leading edges in the correct side with the slot positioned horizontally. Note:  
The Wizard wing requires the washout rod to be routed through the hole in the undersurface.  
The Streak velcro tabs need to be positioned aft of the leading edge.  
It should be impossible to rotate the leading edge if correctly installed.

Install sail tip webbings to tip bung. Pull sail firmly until the loops are located on the end of the leading edge fitting. Ensure the webbing is centrally located. Secure velcro tabs on the inside of the leading edge. Repeat for the other leading edge

Insert the battens and assemble the wing as per the assembly instructions in this manual.

Preflight as described in the manual paying particular attention to possible damage to the airframe during transport.

NOTE: If you find difficulty pulling the sail tension on the leading edges the sail nose tabs can be remove to allow the sail to move back. It is, however, extremely important to check that the sail at the nose does not foul on the frame when the wing is being tensioned.

### **10.5 Maintenance Schedules**

Airborne microlights have been designed to permit easy inspection, and operators should have no difficulty in assessing problems or recognising damage if visual checks are carried out correctly.

General care should include:

- Washing down the tube work with warm water and a light detergent followed by rinsing with fresh water.
- Fabric sponged with warm water and a mild detergent and rinsed with fresh water.
- The pod and wheel spats washed and polished using commercially obtainable shampoos and polishes.
- Treat all exposed metal components (including the engine) on the trike base (only) with a dewatering compound such as WD40 or CRC spray. This guards against corrosion and makes cleaning much easier.
- Lubricate the throttle cables regularly using a light machine oil.
- The cockpit area should have all litter removed to minimise corrosion and to safeguard the propeller.

Apart from the consequences of heavy landing, or of exceeding flight limitations, the major factors requiring attention are corrosion and fatigue.

There are no inherent fatigue problems with the Airborne microlights, but excessive loads and vibration can weaken the structure. Regular inspection for hair-line cracks in areas under high stress, such as bolt holes, tube junctions, etc is recommended.

Many components can be replaced with ease, and for difficult repairs consult your Airborne Agent or the Airborne Factory.

The registration of microlights is only valid provided that all necessary Maintenance, Modification and Service requirements are fulfilled.

These requirements include:

- (a) Maintenance of aircraft as per the Maintenance Schedule in this handbook;
- (b) Modification as detailed in any relevant Airworthiness Directives.
- (c) Modification to approved details, obtained from Airborne WindSports Pty. Ltd.;
- (d) Repairs necessary to replace minor damage, wear or ageing.
- (e) Servicing, replacement and overhaul, inspection and checking in compliance with the Maintenance Schedule.

Your microlight should be maintained in accordance with the following schedules.

Within these schedules the following codes are used:

**Code:**

- 1 Oil lubricate, clean and service.
- 2 Check as directed.
- 3 Check for insecurity, cracks, wear and faulty operation.
- 4 Remove, inspect and replace if necessary.
- 5 Recommend replacement or overhaul.
- 6 Mandatory Replacement

**Log Book**

When maintenance is performed always check appropriate square. The hourly maintenance should be dated and initialled on the appropriate maintenance schedule table.

©AirBorne WindSports Pty. Ltd.  
**PILOT HANDBOOK - EDGE SERIES MICROLIGHTS**

10.5.2 Propeller and Gearbox Maintenance Schedule

**WARNING - DISCONNECT SPARK PLUG LEADS FOR ALL MAINTENANCE AND INSPECTION PROCEDURES!**

ITEM	MAINTENANCE REQUIREMENT	AIRCRAFT or ITEM - HOURS OF OPERATION																					
		25	50	75	100	125	150	175	200	225	250	275	300	325	350	375	400	425	450	475	500	1000	
PROPELLER	Examine for nicks and abrasions	2	2	2	2	2	2	2	2	2	2	2	2	2	2	2	2	2	2	2	2	2	
	Check security of blades	2	2	2	2	2	2	2	2	2	2	2	2	2	2	2	2	2	2	2	2	2	
	Check security and retorquing <sup>6</sup> mounting bolts, & sandwich plates. (Retorque every 2 hours for first 10 hours)	2	2	2	2	2	2	2	2	2	2	2	2	2	2	2	2	2	2	2	2	6	
	Check minimum 50mm clearance between tip & airframe keel				2				2				2				2				2	2	
	Rotate propeller to check out of track conditions - 3mm maximum at tips				2				2				2				2				2	2	
	Protective Blade Tape	3	3	3	3	3	3	3	3	3	3	3	3	3	3	3	3	3	3	3	3	3	
	Check hub section for cracks				4				4				4				4				4		
	Check Balance				4				4				4				4				4		
	CLEAR PROP Placard		3		3		3		3		3		3		3		3		3		3	3	
	REDUCTION GEAR BOX	All welds		3		3		3		3		3		3		3		3		3		3	3
All Bolts			3		3		3		3		3		3		3		3		3		3	3	
Oil Leaks			2		2		2		2		2		2		2		2		2		2	2	
Breather Clear and Unobstructed, Tie Wire intact			2		2		2		2		2		2		2		2		2		2	2	
Reduction Gearbox									4								5					5	
Change Gearbox Oil(initially after 10 Hours)					1				1				1				1					1	
Bearing security		2	2	2	2	2	2	2	2	2	2	2	2	2	2	2	2	2	2	2	2	2	
Adjustment within tolerance		2	2	2	5	2	2	2	5	2	2	4	5	2	2	2	5	2	2	2	2	5	5
Release cable					2				2				2				5					5	5
DATE & INITIAL																							
Date and Initial Appropriate Box to record that maintenance has been carried out.																							

**Code:**

- 1 Oil lubricate, clean and service.
- 2 Check as directed.
- 3 Check for insecurity, cracks, wear and faulty operation.
- 4 Remove, inspect and replace if necessary.
- 5 Recommend replacement or overhaul.
- 6 Mandatory Replacement

6 Use appropriate torque wrench. DO NOT OVER TIGHTEN

© AirBorne WindSports Pty. Ltd.  
**PILOT HANDBOOK - EDGE SERIES MICROLIGHTS**

### 10.5.3 Engine Maintenance Schedule

**WARNING - DISCONNECT SPARK PLUG LEADS FOR ALL MAINTENANCE AND INSPECTION PROCEDURES!**

ITEM	MAINTENANCE REQUIREMENT	AIRCRAFT or ITEM - HOURS OF OPERATION															
		25	50	75	100	125	150	175	200	225	250	275	300	325	350	375	400
ENGINE	Overhaul																5
	Oil leaks which could indicate cracks or blown gaskets or seals		2		2		2		2		2		2		2		2
	Cylinders, fins and baffles		3		3		3		3		3		3		3		3
	All welds		3		3		3		3		3		3		3		3
	Loose Bolts	4	4	4	4	4	4	4	4	4	4	4	4	4	4	4	4
	Engine Rubber Mounts		3		4		3		5		3		4		3		5
	Engine Platform, Mounting Plates Check for		2		2		2		2		2		2		2		2
	Spark Plugs (CLEAN EVERY TEN HOURS)	5	5	5	5	5	5	5	5	5	5	5	5	5	5	5	5
	Spark Plugs and Ignition Harness Secure		2		2		2		2		2		2		2		2
	Crankcase and mounting lugs free from cracks.		2		2		2		2		2		2		2		2
	Fuel Lines routed properly (free from abrasion, heat & sharp edges) - fittings tight.	2	2	2	4	2	2	2	4	2	2	2	4	2	2	2	5
	Fuel Tank located and secure / no leaks or cracks. Webbing tensioned		3		3		3		3		3		3		3		3
	Fuel Filter		5		5		5		5		5		5		5		5
	Fuel Pump																5
	Starting Cord	3	3	3	3	3	3	3	3	3	3	3	3	3	3	3	3
	Starter Cup - Check for cracks around mounting holes		4		4		4		4		4		4		4		4
	Throttle Cable (Few drops light lube oil each day)	1	3	1	4	1	3	1	4	1	3	1	4	1	3	1	5
	Air Cleaner	1	1	1	1	1	1	1	1	1	1	1	1	1	1	1	5
	Check exhaust Ports for Carbon Buildup		2		2		2		2		2		2		2		2
	Muffler (See note)		4		4		4		5		4		4		4		5
	Muffler Springs				5				5				5				5
	Tie Wire		3		5		3		5		3		5		3		5
	Ignition switch ON/OFF identification		2		2		2		2		2		2		2		2
Engine earthing cable		2		2		2		2		2		2		2		2	
Carburettor		3		3		3		3		3		3		3		3	
Main Carburettor Needles		4		4		4		4		4		4		4		4	
DATE & INITIAL																	
Date and Initial Appropriate Box to record that maintenance has been carried out.																	

**Note:** Do not over tighten the two 5/16" horizontal exhaust-mounting bolts. Over tightening will limit the movement of the rubbers, which may cause cracking of the exhaust system.

The nut should be tightened so that there is only 1 to 2 threads protruding from the nut. A gap of up to one millimeter between the rubber face and the exhaust lug is acceptable

**Code:**

- 1 Oil lubricate, clean and service.
- 2 Check as directed.
- 3 Check for insecurity, cracks, wear and faulty operation.
- 4 Remove, inspect and replace if necessary.
- 5 Recommend replacement or overhaul.
- 6 Mandatory Replacement

©AirBorne WindSports Pty. Ltd.  
**PILOT HANDBOOK - EDGE SERIES MICROLIGHTS**

10.5.4 Engine Maintenance Schedule

**WARNING - DISCONNECT SPARK PLUG LEADS FOR ALL MAINTENANCE AND INSPECTION PROCEDURES!**

ITEM	MAINTENANCE REQUIREMENT	AIRCRAFT or ITEM - HOURS OF OPERATION															
		25	50	75	100	125	150	175	200	225	250	275	300	325	350	375	400
ENGINE	Fuel Capacity/Mixture Placard		3		3		3		3		3		3		3		3
	Wiring Loom Placard		3		3		3		3		3		3		3		3
	Fuel Tap Position Placard		3		3		3		3		3		3		3		3
	Engine Earthing Placard		3		3		3		3		3		3		3		3
	Cylinder Head Temperature Operation	2	2	2	2	2	2	2	2	2	2	2	2	2	2	2	2
	Engine Tachometer Operation	2	2	2	2	2	2	2	2	2	2	2	2	2	2	2	2
	Engine Hourmeter Operation	2	2	2	2	2	2	2	2	2	2	2	2	2	2	2	2
	Replace Engine Coolant (582 only)				4				4				4				4
	Cooling System Hoses (See note below) (582 only)		3		3		3		3		3		3		3		3
	Radiator Mounting Rubbers (582 only)		3		3		3		3		3		3		3		3
Ground run at full throttle, note static rpm in log book. If low check engine tuning and propeller pitch settings.		2		2		2		2		2		2		2		2	
<b>DATE &amp; INITIAL</b>																	
Date and Initial Appropriate Box to record that maintenance has been carried out.																	

**Note** If it necessary to replace the radiator hoses it is important that the replacement hoses are identical to that supplied with the aircraft. The engine coolant is circulated rapidly through the cooling system and the fitting of hoses other than that supplied can increase the flow resistance leading to excessive coolant temperatures.

**Code:**

- 1 Oil lubricate, clean and service.
- 2 Check as directed.
- 3 Check for insecurity, cracks, wear and faulty operation.
- 4 Remove, inspect and replace if necessary.
- 5 Recommend replacement or overhaul.
- 6 Mandatory Replacement

© AirBorne WindSports Pty. Ltd.  
**PILOT HANDBOOK - EDGE SERIES MICROLIGHTS**

### 10.5.5 Wing Airframe Maintenance Schedule

ITEM	MAINTENANCE REQUIREMENT	AIRCRAFT or ITEM - HOURS OF OPERATION																
		25	50	75	100	125	150	175	200	225	250	275	300	325	350	375	400	
WING AIRFRAME	Wing Fabric deterioration and tears		2		2		2		4		2		2		2		5	
	Wing Fabric Stitching		2		2		2		2		2		2		2		5	
	Wing Fabric attachment points		3		3		3		4		3		3		3		3	
	Batten Elastics		3		3		3		5		3		3		3		5	
	Check Battens against template supplied	2	2	2	2	2	2	2	2	2	2	2	2	2	2	2	2	2
	Wing wires and attachment fittings		3		3		3		3		3		3		3		4	
	Check leading edges, keel & A Frame for straightness, dents and corrosion		2		2		2		2		2		2		2		4	
	Remove leading edges, cross bar, keel & A Frame structural members and check for fatigue cracks radiating from drilled holes.																4	
	Check reflex bridle luff lines for kinks		2		2		2		2		2		2		2		4	
	Check Inspection Zips		2		2		2		2		2		2		2		2	
	All aircraft bolts, nuts, washers & safety pins. Washers under each nut & at least one thread showing outside each nut.		2		2		2		2		2		2		2		2	
	Check universal joint for wear or damage		2		2		2		2		2		2		2		2	
Main Hang Bolt	2	5	2	5	2	5	2	5	2	5	2	5	2	5	2	5		
<b>DATE &amp; INITIAL</b>																		
Date and Initial Appropriate Box to record that maintenance has been carried out.																		

**Code:**

- 1 Oil lubricate, clean and service.
- 2 Check as directed.
- 3 Check for insecurity, cracks, wear and faulty operation.
- 4 Remove, inspect and replace if necessary.
- 5 Recommend replacement or overhaul.
- 6 Mandatory Replacement

©AirBorne WindSports Pty. Ltd.  
**PILOT HANDBOOK - EDGE SERIES MICROLIGHTS**

### 10.5.6 Trike Base and Landing Gear Maintenance Schedule

ITEM	MAINTENANCE REQUIREMENT	AIRCRAFT or ITEM - HOURS OF OPERATION																			
		25	50	75	100	125	150	175	200	225	250	275	300	325	350	375	400	425	450	475	500
TRIKE BASE	All structural members and attachments	3	3		3		4		3		3		3		4		3		4		4
AND LANDING GEAR	Check Trike base tube behind sleeves for signs of cracking or bending.				2				2				2			2				2	
	Check Trike Mast behind sleeves for signs of cracking or bending.				2				2				2			2				2	
	Pivot Points	1	1	1	4	1	1	1	4	1	1	1	4	1	1	1	4	1	1	1	4
	Suspension Bungie Elastics		3		4		3		4		3		4		3		4		3		4
	Main and Nose wheels		3		4		3		4		3		4		3		4		3		4
	Cushion Rubbers (Front Suspension) X series		3	3	5	3	3	3	5	3	3	3	5	3	3	3	5	3	3	3	5
	Wheel and steering bearings	1	1	1	4	1	1	1	4	1	1	1	4	1	1	1	4	1	1	1	4
	Brake Pads and assembly				4				4				4				4				4
	Brakes check for correct operation		2		2		2		2		2		2		2		2		2		2
	Tyres		2		2		2		2		2		2		2		2		2		2
	Wheel Rims		3		3		3		3		3		3		3		3		3		3
	Steering Dampener		3		3		3		3		3		3		3		3		3		3
	Steering Interlock		3		3		3		3		3		3		3		3		3		3
	Steering Gear Bronze Bushes		3		3		3		3		3		3		3		4		3		3
	Front Mast Brace	3	3	3	3	3	3	3	4	3	3	3	3	3	3	3	4	3	3	3	3
	Check Seats and Attachments		2		2		2		2		2		2		2		2		2		2
	Check Seat Safety Harness for damage, deterioration & Security, check latches for faulty operation.		2		2		2		2		2		2		2		4		2		2
	ASI Pitot - Check for Blockage, condensation	2	2	2	2	2	2	2	2	2	2	2	2	2	2	2	2	2	2	2	2
	Compass - Check Deviation								2								2				
	Compliance Placard		3		3		3		3		3		3		3		3		3		3
	Step/No Step Placards		3		3		3		3		3		3		3		3		3		3
	Caution Placard		3		3		3		3		3		3		3		3		3		3
	Notice Placard		3		3		3		3		3		3		3		3		3		3
	Flight Limitations Placard		3		3		3		3		3		3		3		3		3		3
	Dual Ignition Placard		3		3		3		3		3		3		3		3		3		3
	VNE Placard		3		3		3		3		3		3		3		3		3		3
	Repack Parachute (If Applicable) - Every 4 Years				2				2				2				2				2
	<b>DATE &amp; INITIAL</b>																				
	Date and Initial Appropriate Box to record that maintenance has been carried out.																				

**Code:**

- 1 Oil lubricate, clean and service.
- 2 Check as directed.
- 3 Check for insecurity, cracks, wear and faulty operation.
- 4 Remove, inspect and replace if necessary.
- 5 Recommend replacement or overhaul.
- 6 Mandatory Replacement

## **10.6 Engine Maintenance**

### **10.6.1 Engine Power**

- Spark plugs should be the type recommended by the manufacturer in Section 11.1 of this handbook.
- Adjusting a carburettor is a specialised job and can have a large effect on the power being developed.
- Altitude can also effect the power available. When moving to a field with a different elevation it may be necessary to retune the carburettor.
- It is suggested that the engine should only be tuned by a qualified person.

### **10.6.2 Air Filter Service Instructions**

These service instructions apply to K&N air filters type RC-2820.

- (1) Tap the element to dislodge any large embedded dirt, then gently brush with a soft bristle brush.
- (2) Spray K&N air filter cleaner liberally onto the entire element and let soak for 10 minutes. **DO NOT USE** petrol, steam, detergents or other cleaning solutions or solvents. Any of these products can cause harm to the cotton filter or shrinkage or hardening of the rubber end caps.
- (3) Rinse off the element with low pressure water. Tap water is OK. Always flush from the clean side to the dirty side. This removes the dirt and does not drive it into the filter.
- (4) Shake off all excess water and let the element dry naturally. **DO NOT USE** compressed air, an open flame or other heat dryers. Compressed air will blow holes in the element while excess heat will cause the cotton filter to shrink.
- (5) Apply K&N air filter oil to the filter after it is dry. Apply the oil along the top and bottom of each pleat. Wait 20 minutes and re-oil any white spots still showing.

## **10.7 Propeller Service and Adjustment**

### **10.7.1 Wooden Blade Propellers**

Because of the nature of the material from which they are made, wooden propellers are relatively easily damaged by stones and other hard objects. They may also be affected by sudden changes in temperature and humidity.

#### **A Inspection**

Wooden propellers should frequently be inspected for breaks in the surface finish, scores, nicks, cracks, delamination, and security of the leading edge sheath. Minor defects in the surface finish may be repaired by touching-up with varnish or paint as appropriate, but any damage to the wood, other than very minor damage must be assessed in accordance the approved repair schemes, and the propeller repaired or returned to the manufacturer as appropriate.

The intervals at which the propeller must be removed for inspection are specified in the Maintenance Schedule.

**WHEN WORKING ON THE PROPELLER  
REMOVE THE SPARK PLUG LEADS FROM  
THE SPARK PLUGS.**

With the propeller removed from the aircraft, the blades and boss should be inspected for the sort of damage described above paying particular attention to those areas which are not visible when the propeller is installed. In addition, the following inspections should be carried out:-

- Bolt holes should be examined for out of round, rough edges, and cracks radiating into the boss.
- Boss faces should be examined for damage where they have been in contact with the hub flanges, particularly at the circumference of the flanges.
- The centre bore should be examined for cracks and delamination of the plies.
- The mounting hub should be examined for corrosion, cracks, correct fit on the crankshaft, and for condition of the attachment bolts and nuts.

## **B Installation**

Before installing a propeller, the propeller shaft and threads should be checked for damage. Boss and hub flange faces should be checked for cleanliness, to ensure that maximum friction will be obtained.

When assembling the hub to the shaft, it is recommended that an anti-seize compound should be applied to the threads.

The angular position of the propeller on the hub is not important.

Clearance between wing wires and tubes, and the propeller should always be maintained. This should be checked in all possible configurations of propeller and wing.

### **(a) Airborne(Ivo) Propeller**

The attachment bolts should be tightened evenly, and in proper sequence, to a torque of 12.5 ft lb (17.5 NM).

After installation, the track of the propeller must be checked. This is measured from the propeller tip to the landing wire. When the propeller is rotated the blades should track within 3mm of each other. A greater tolerance may be permitted on repaired propellers, provided that no vibration is evident during engine runs. Adjust propeller track by tightening the mounting bolts.

Tighten lock nuts once bolts are correctly tensioned.

After engine runs to check for vibration the propeller attachment bolts should be checked for tightness, and the lock nuts checked for tightness. It is recommended that the bolts should also be checked after each of the first few flights after the propeller has been refitted.

If it becomes necessary to replace a blade in a Airborne(Ivo) ground adjustable propeller it is important to obtain a replacement blade from the Airborne factory.

*The Ivo (shim) pitch adjustment* system has a cam installed on the torsional rod of each blade. The 6 shims are used to limit the movement of the cam reacting against the engine plate.

Your aircraft was delivered with a correctly adjusted propeller however if adjustment is required the following procedure should be used:

- (1) Remove the propeller from the hub.
- (2) Take one shim from the rear and place forward of the propeller hub to increase pitch. (reduce engine RPM). Take one shim from the front and place on the rear of the propeller hub to decrease pitch. (increase engine RPM).
- (3) Replace propeller and tension as outlined above.

*The Ivo (quick) pitch adjustment* system has a cam installed on the torsional rod of each blade. The cam fits into the groove of the screw adjuster which causes the cam to rotate the torsion rod thereby increasing or decreasing pitch.

Your aircraft was delivered with a correctly adjusted propeller however if adjustment is required the following procedure should be used:

- (1) Remove tie wire and loosen lock nut.
- (2) Turn adjuster screw clockwise to increase pitch (reduce engine RPM). Turn adjuster screw clockwise to increase pitch (reduce engine RPM).
- (3) Once correctly adjusted tighten lock nut and tie wire around thread and through hole.

### (b) GSC Ground Adjustable Propeller

If it becomes necessary to replace a blade in a GSC ground adjustable propeller it is important that the replacement blade is of the same balance number. This number is stamped on each blade adjacent to the hub. When ordering new blades be sure to quote the balance number of the remaining blades.

To assemble the propeller place one half of the hub on a large flat surface and insert blades ensuring that the direction of airflow over each blade is the same.

Place the other half of the hub over the root of the propeller blades. The hubs are supplied as a matched set and it is important to assemble the hubs to align the numbers stamped on the end of each hub. It may be necessary to move the blades up and down slightly to allow the retaining ring in the hub to slip into the root end of the blade.

With the two halves of the hub together insert AN4-24 bolts into the holes in the hub which are on the outside of each hub arm. Be sure to use washers under both the head of the bolt and the nut. Use AN4 full lock nuts. Do not tighten all the way as the blades must be free to move so that blade adjustment can be made.

Blade pitch angle must now be set. Raise the hub of the surface of your work area so that the blades clear the working surface when they are rotated to the desired angle.

Use a template similar to those shown in the adjacent diagram set the blade angle at a position along the blade 600 mm from the centre of the hub.

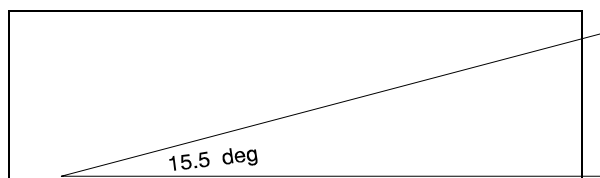

It is necessary to set the blade angle so that the space between the leading edge and the template is equal to the space between the trailing edge and the template. As you adjust each blade tighten the bolts just enough to stop the blade from rotating while you are adjusting the other blades.

When you have adjusted all blades tighten the bolts a little more securely so the blades will not be jarred out of position while mounting the propeller. **DO NOT OVER TIGHTEN.**

Six 8mm torque studs are used in the propeller flange to transmit engine torque to the propeller. These studs screw into the flange. Loctite is used to secure them.

With the torque studs in position place the propeller assembly on the flange and fix in position with the bolts provided. **DO NOT TIGHTEN THE MOUNTING BOLTS AT THIS STAGE.**

Torque all bolts to **100 inch pounds** or **8.5 ft lbs** using a torque wrench that is accurate at low torque settings. Bring each bolt up to the proper torque by gradually increasing the torque on each bolt in the sequence. **DO NOT** bring one bolt up to torque and then go onto the next one. When tightening specified bolts tighten them in a crossing pattern. Bring each bolt up to the proper torque several times.

**ALWAYS TIGHTEN THE BOLTS IN THE  
CORRECT SEQUENCE AND TO THE  
SPECIFIED TORQUE.**

Use the following sequence:

- (1) Tighten bolts which pass through the centre of the blade roots first.
- (2) Tighten the remaining bolts that mount the propeller to the drive shaft.
- (3) Tighten the bolts at the end of each hub arm.

After tightening hub bolts to the torque specified it is important to ensure positive clearance always exists between the two hubs as an indication of elastic clamping of blade hubs. Operation after over tightening of mounting bolts to the extent that hub halves meet can cause severe damage or failure of the blade hubs.

Fit lock nuts to the mounting bolts once the correct torque settings are obtained.

After installation, the track of the propeller must be checked. This is measured from the propeller tip to the landing wire. When the propeller is rotated the blades should track within 3mm of each other. A greater tolerance may be permitted on repaired propellers, provided that no vibration is evident during engine runs.

## PILOT HANDBOOK - EDGE SERIES MICROLIGHTS

If the tracking is out check that the blade angles have been set correctly. If tracking is still out loosen the hub mounting bolts and retighten them and check again. If the tracking is still out remove the propeller and check that there is no dirt or other foreign matter fouling the on the mounting flange. If the problem persists consult you dealer or the factory.

After engine runs to check for vibration the propeller attachment bolts should be checked for tightness, and re-wired. It is recommended that the bolts should also be checked after each of the first few flights after the propeller has been refitted.

### (c) Brolga Propeller

#### ASSEMBLY

Place hub on a flat surface with the nyloc nuts facing up. Remove nuts, washers, hub half and uppermost pitch blocks.

Fit blades with flat face up. Hub halves and blades are marked with indented dots. These should all correspond when the hub is assembled. The code mark on the blade is on the leading edge where it fits into the hub.

Replace pitch blocks, hub half, washers (two under each nut), and nuts and tighten to 11 ft lbs.

When fitting the propeller to the engine/gearbox it is essential that the crush plate be fitted to the outside of the propeller to distribute the compression loads from the mounting bolts.

Torque hub to gearbox mounting bolts to 14 ft lbs. Bolts should be re-tensioned in accordance with the maintenance schedule.

#### MAINTENANCE

1. The propeller has no definite life. An expectation of 2000+ hours is not unrealistic provided an appropriate inspection and maintenance schedule is adhered to.

2. The inspection / maintenance procedures to be adopted are as follows:

- a) Every 20 hours:- retorque blade bolts to 11 ft.lbs. and the 6 hub mounting bolts to 14 ft.lbs.
- b) Every 200 hours:- dismantle the propeller and perform an inspection for cracks in the blades and in particular the integral steel hub reinforcement plate. After disassembly, visually inspect the blades, hub halves, pitch blocks and bolts for signs of wear, cracking or other damage. If cracks are found, then the item should be replaced or returned to the manufacturer for evaluation and/or repair. The bolt holes and splines should also be inspected for wear or elongation. The blade should also be inspected for water ingestion and delamination.

Any prop strike from any cause whatsoever should be grounds for complete prop inspection. The presence of any stress fractures emanating from the bolt holes in the blades should dictate replacement of the blade/s in question. Patches of surface corrosion on the blade bolts is not acceptable- replacement is mandatory.

- c) Every 1000 hours:- replace blade bolts.

#### BLADE DAMAGE REPAIR

Small stone chips along the entire blade length (up to 5mm long and extending no further than 2mm from the blade leading edge) may be filled with a good quality epoxy resin after thorough cleaning and de-greasing with MEK or single solvent. Slow setting "Araldite" (KI06) is recommended. The 5-Minute types are NOT acceptable. In the event of substantial damage, return prop to manufacturer for evaluation.

### C Ground Run

Adjustment of the propeller to other blade angles is not recommended unless the final full power engine operating speed is able to be checked by the use of a tachometer.

The engine speed for a full throttle static ground run for a correctly adjusted propeller is as follows:

- Rotax 582 Engine 6400 rpm; and
- Rotax 503 Engine 6500 rpm.

## **10.8 Airframe (Wing) Maintenance and Tuning**

### **10.8.1 Airframe Tubing**

#### **A Installation & Removal**

When removing tubing do not bend or force tubes. When installing do not distort tubing from its original shape.

#### **B Inspection**

Inspect tubing for cracks, damage from abrasion, elongated holes or distortion in tube surface.

**NEVER ATTEMPT TO REPAIR TUBING,  
ALWAYS REPLACE WITH NEW PART.**

#### **C Corrosion**

Inspect tubing for corrosion inside and out. Discolouration of the metal may indicate corrosion. Salt is the most common cause, during coastal operations. Parts affected by salt must be stripped and thoroughly cleaned before reassembly. The cause of the corrosion must be identified and eliminated. If corrosion is present the component must be removed and replaced with a new part.

#### **D Replacement**

Aluminium tube comes in many different sizes and grades. As sections of the airframe are manufactured from tube made specifically to Airborne's Specification it is important that only genuine replacement parts, supplied by Airborne WindSports Pty. Ltd are used.

### **10.8.2 Airframe Bolts**

All airframe bolts are either Aircraft Quality or High Tensile Bolts. If it necessary to replace any bolts or nuts it is important that the specification of the original bolt are matched when a replacement is selected. This applies not only to the grade of the bolts but to the length as well.

#### **A Installation & Removal**

- After tightening, all bolts should have at least 1 to 2 threads showing.
- All self-locking nuts should not be installed more than 2 times.
- A washer should always be installed under the nut.
- Be sure not to over-torque bolts when installing.
- Check assembly instructions for correct bolt placement.

#### **B Inspection**

- Check bolts for worn shanks, bad threads or corrosion.

### 10.8.3 Sails

#### A Installation & Removal

When installing or removing the sail you will need a large unobstructed area of approximately 12 meters by 3 meters. Make sure the surface is clean and not abrasive. Rough concrete will damage the sail.

It is a good practise to have a small container to put the hardware in during disassembly.

<b>Removal of sail from the frame</b>	<b>Streak Wing</b>	<b>Wizard Wing</b>
Lay the wing on its back and remove the bag and padding. Set the battens aside.	√	√
Spread the leading edges and raise the nose approximately ½ meter.	√	√
Undo velcro and dismount the webbing from the rear leading edge. This removes leading edge tension allowing easier access to the cross bar junction.	√	√
Disconnect side wires from the bottom of the control frame. Remove shackles from the wires and feed the wires through exit holes in the sail. Set base tube aside.	√	√
Remove the rear quick clip block. This will disconnect the rear wires and the sail keel pocket webbing.	√	√
Disconnect the two downtubes and set aside.	√	√
Remove sail nose webbings from the nose plate bolts. Replace nuts.	√	√
Disconnect king post nose wire and feed through the sail.	√	√
Disconnect the top side wires at the cross bar leading edge junction and replace the nuts. Feed the wires through the sail hole. Do not remove the lower rigging from the cross tubes.	√	√
Remove the top rear wire from the pull back shackle. Set the king post aside.	√	√
Remove the cross bars from the cross bar channel.		√
Disconnect the cross bar webbing strap from one side of the cross bar. Remove cross bars.	N/A	√
Unzip the centre zip completely. Remove bungie and zip slider.	√	
Lower the nose of the wing, bring leading edges together. Slide the frame forward through the nose of the sail. If you encounter any resistance, stop and check what is catching.	√	√

©AirBorne WindSports Pty. Ltd.  
**PILOT HANDBOOK - EDGE SERIES MICROLIGHTS**

<b>Re-installing the sail on the frame</b>	<b>Streak Wing</b>	<b>Wizard Wing</b>
Fold the sail in half with the mylar pockets facing inward. Slide the frame through the nose of the sail.	√	√
Ensure the undersurface velcros are located on the rear side of the leading edges.	√	N/A
Ensure the washout rods are fed through the sail holes at the tip.	N/A	√
Spread the leading edges and raise the nose approximately ½ meter. The wing should be on its back.	√	√
Connect cross bar webbing strap over the keel and connect to the other cross bar.	N/A	√
Feed the cross bars through the undersurface holes and attach the cross bars to the channel.	N/A	√
Feed the top side wires through the sail and connect to the cross bars. Feed the lower rigging through the appropriate sail holes.	√	√
Connect the king post nose wire. Check the nose cone is still on the wires prior to feeding the wire through the sail. Attach the sail nose webbings to the nose plate bolts.	√	√
Install the webbing on the rear leading edge. Secure velcro retainer tabs.	√	√
Feed cross bar pull back wires through the king post hole and attach top rear wire.	√	√
Connect down tubes and side wires to control frame.	√	√
Replace quick clip . Attach keel pocket webbing and rear wires.	√	√
Connect the bungie to the webbing pull back handle.	√	N/A
Tension cross bars. Install tip protectors and sail attachment screw.	√	√
Finish assembling the wing in accordance with the manual.	√	√
Carefully preflight the wing in accordance with the manual.	√	√

## **B Inspection**

- Check for tears in the sail cloth or any loose or unravelled seams.
- Check all webbing securing points are not damaged or worn.
- Check all inspection zippers to see if they function smoothly and close completely.

## **C Protection**

Ultraviolet radiation from strong sunlight can ultimately reduce the strength of Dacron, but this may be reduced to an acceptable level by careful consideration of the wings use and exposure. In its bag the wing is fully protected.

**KEEP THE SAIL COVERED WHEN NOT IN USE AS CONTINUED EXPOSURE TO ULTRAVIOLET RADIATION DRAMATICALLY REDUCES SAIL LIFE.**

The Dacron sailcloth may be cleaned with warm soapy water. Strong detergents must not be used. Thorough rinsing with plenty of clean water must follow.

**NEVER USE CHEMICAL SOLVENTS OR APPLY WATER REPELLENT COMPOUNDS.**

### 10.8.4 Tuning

Your aircraft was test flown and delivered to you in good flying order. Qualified personnel should only carry out adjustments to the wing. Any adjustments should be recorded in the maintenance log.

If you feel that the wing requires adjustment to trim in the roll or the pitch axis you should check that the problem is not caused by something asymmetrical in the frame or the battens. In order of priority check the following:

- Ensure that the wires, including the reflex bridles are correctly routed
- Check the battens against the template
- Check the keel is straight
- Check that the sail is correctly mounted on the leading edges
- Check that the leading edges are straight and that the rear leading edges are located correctly
- Check leading edge tensions are set evenly. Wizard on 4<sup>th</sup> mark. Streak on 5<sup>th</sup> mark.

To check your battens use the following procedure:

- Lay the template out on a flat surface.
- Note whether the battens have been reflexed. Do not change the reflex initially.
- Start with the keel batten lining the nose of the batten up with the start of the line. The line should be above batten.
- If the batten does not line up, gently apply pressure using your hand or knee to get a smooth curve.
- Battens should be checked after 25 hours airtime.

After checking as outlined at the beginning of this section a turn can be remedied by the following methods:

	Adjustment Method	Remedy Left Turn	Remedy Right turn
VERY MILD TURN	<b>STRUTT TENSION</b> WIZARD WING The knot on the bungee should be adjusted to increase or decrease the tension on the tip strut.	WIZARD WING Increase the tension on the left strut by "shortening" the bungee.	WIZARD WING Increase the tension on the right strut by "shortening" the bungee.
	STREAK WING The over centre strut should be rotated to adjust the tension. The lock nut should be loosened prior to rotation. The strut should be unloaded prior to adjustment. Clockwise adjustment of the strut reduces tension and anti-clockwise adjustment increases tension.	STREAK WING Increase the tension on the left strut by 2-4 turns. The tension on the right can be decreased the same amount if required.	STREAK WING Increase the tension on the right strut by 2-4 turns. The tension on the left can be decreased the same amount if required.
MILD TURN	<b>TIP ANGLE ADJUSTEMENT</b> The angle of the tip can be adjusted by rotating the angle of the tip. Adjustment requires removal of the stainless screw, which secures the tip webbing bung. The tip bung is rotated and the screw is re installed in the appropriate hole.	STREAK & WIZARD WING Rotate the left tip down (clockwise) 1 hole and re install screw. If more adjustment is required rotate the right tip up (clockwise) 1 hole and re install screw.	STREAK & WIZARD WING Rotate the right tip down (anti clockwise) 1 hole and re install screw. If more adjustment is required rotate the left tip up (anticlockwise) 1 hole and re install screw.
MORE SIGNIFICANT TURN	<b>BATTEN REFLEX ADJUSTMENT</b> One of the most effective ways to tune a more significant turn is to reflex the root battens. The batten profile has a dashed line defining the reflex required. The wing needs to be removed from the base and de tensioned. The battens should be shaped to the template and re installed.	STREAK WING The battens (#3,4,5&6) on the left side should be reflexed as per batten profile. WIZARD WING The battens (#2,3&4) on the left side should be reflexed as per batten profile.	STREAK WING The battens (#3,4,5&6) on the right side should be reflexed as per batten profile. WIZARD WING The battens (#2,3&4) on the right side should be reflexed as per batten profile

If the turn persists after tuning consult your authorised dealer or the factory.

### **10.9 Tow Release Adjustment**

- Make sure that the foot release pedal is fully rearward.
- Adjust cable on foot lever so that the adjuster is fully in.
- Use cable adjuster on release to set the dimension shown in the adjacent diagram
- Test the release for correct operation.

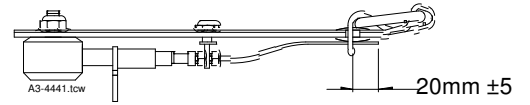

## **11 SUPPLEMENTS**

### *11.1 Rotax Engine Manual*

THIS PAGE INTENTIONALLY BLANK

***11.2 BRS Emergency Parachute Manual***

THIS PAGE INTENTIONALLY BLANK